



User Instructions

Gas fired condensing combi boiler

Condens 8000

GC8700iW 33/36 C | GC8700iW 33/40 C

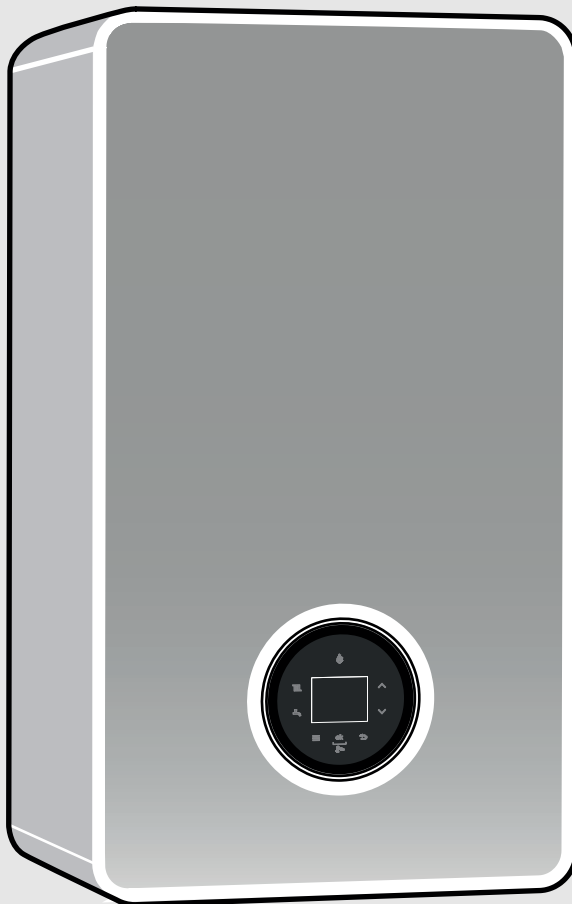

Table of contents

1	Explanation of symbols and safety instructions	3
1.1	Explanation of symbols	3
1.2	General safety instructions	3
2	Product Information	5
2.1	Declaration of Conformity	5
2.1.1	Declaration of conformity	5
2.1.2	Simplified EU Declaration of Conformity regarding radio equipment.	5
2.2	Appliance identification and serial number	5
2.3	Servicing	5
2.4	Maintaining your appliance	5
2.5	Benchmark standard	6
3	Prepare for operation	6
3.1	Sealed heating system	6
3.1.1	Checking the system pressure	6
3.1.2	Low pressure indication.	6
3.1.3	Constantly re-pressurising the system	6
3.2	Topping up the system pressure	7
3.2.1	Greenstar Intelligent Filling System (accessory)	7
4	Operating the appliance	7
4.1	Control panel overview	7
4.2	Symbols in the display	8
4.3	Adjusting the appliance flow temperature	8
4.3.1	Heating key	8
4.4	Hot water mode	9
4.4.1	Hot water key	9
4.5	Operating the menu	9
4.6	Settings in the menu	9
5	Key (accessories)	10
5.1	Installing the Key	10
5.2	Key LED	10
5.3	Setting the time program	10
6	Shutdown	11
6.1	Setting frost protection	11
7	Thermal disinfection	11
8	Clearances and ventilation information	11
8.1	Appliance clearances	11
8.2	Ventilation information	11
9	Malfunction or failure	12
9.1	Troubleshooting (fault reset)	12
9.2	Fault 2980	12
9.3	Troubleshooting	12
9.4	Extreme cold weather	13
9.5	System gassing troubleshooting	14
10	Environmental protection and disposal	15
11	Data Protection Notice	15
12	Tips on energy saving	16

13	Your guarantee	16
14	Energy consumption	17
14.1	Product data on energy consumption.	17
15	Open Source Software	18
15.1	List of used Open Source Components	18
15.2	Used Commercial Source Components	18
15.2.1	This product contains software developed and licensed by SEGGER Software GmbH	18
15.3	Appendix - License Text	18
15.3.1	BSD (Three Clause License)	18
15.3.2	MCD-ST Liberty Software License Agreement v2	18

1 Explanation of symbols and safety instructions

1.1 Explanation of symbols

Warnings

In warnings, signal words at the beginning of a warning are used to indicate the type and seriousness of the ensuing risk if measures for minimising danger are not taken.

The following signal words are defined and can be used in this document:

 **DANGER**
DANGER indicates that severe or life-threatening personal injury will occur.

 **WARNING**
WARNING indicates that severe to life-threatening personal injury may occur.

 **CAUTION**
CAUTION indicates that minor to medium personal injury may occur.

NOTICE
NOTICE indicates that material damage may occur.

Important information

 The info symbol indicates important information where there is no risk to people or property.

Additional symbols

Symbol	Meaning
▶	a step in an action sequence
→	a reference to a related part in the document
•	a list entry
–	a list entry (second level)

Table 1

1.2 General safety instructions

Notices for the target group

These operating instructions are intended for the heating system operator.

All instructions must be observed. Failure to comply with instructions may result in material damage and personal injury, including danger to life.

- ▶ Read and retain the operating instructions (heat generator, heating controller, etc.) prior to operation.
- ▶ Observe the safety instructions and warnings.
- ▶ Operate the heat generator only with the casing fitted and closed.

Determined use

The product may only be used for the heating of boiler water and for DHW heating.

Any other use is considered inappropriate. We assume no liability for damage occurring due to non-permitted use.

If you smell gas

A gas leak could potentially cause an explosion. If you smell gas, observe the following rules:

- ▶ Prevent flames or sparks:
 - Do not smoke, use a lighter or strike matches.
 - Do not operate any electrical switches or unplug any equipment.
 - Do not use the telephone or ring doorbells.
- ▶ Turn off the gas at the meter or regulator.
- ▶ Open windows and doors.
- ▶ Warn your neighbours and leave the building.
- ▶ Prevent anyone from entering the building.
- ▶ Move well away from the building: call the National Gas Emergency Service on 0800 111 999.
- ▶ L.P.G. boilers: Call the supplier's number on the side of the gas tank.

Danger to life from poisoning by flue gas

There is a danger to life from escaping flue gas.

▶ Never modify any parts through which flue gas is routed.

If flues are damaged or leaking, or if you smell flue gas, observe the following rules.

- ▶ Switch off the heat source.
- ▶ Open doors and windows
- ▶ Warn your neighbours and leave the building immediately.
- ▶ Prevent third parties from entering the building.
- ▶ Notify an approved contractor.
- ▶ Have any defects rectified.

Danger to life from carbon monoxide

Carbon monoxide (CO) is a poisonous gas, which arises during the incomplete combustion of fossil fuels such as oil, gas or solid fuels.

Dangers arise, if carbon monoxide escapes from the heating system due to a fault or a leak and collects unnoticed in enclosed spaces.

You can neither see, taste nor smell carbon monoxide.

To avoid danger from carbon monoxide:

- ▶ Have the heating system inspected and serviced regularly by an approved contractor.
- ▶ Use a CO detector, which gives an alarm in good time if CO escapes.
- ▶ If you suspect a CO leak:
 - Warn your neighbours and leave the building immediately.
 - Call an approved contractor.
 - Have any defects rectified.

Inspection, cleaning and maintenance

The user is responsible for ensuring the heating system is safe and environmentally compatible.

Non-existent or improper inspection, cleaning and maintenance may result in personal injury, including danger to life or material damage.

We recommend that you enter into a contract covering an annual inspection and responsive cleaning and maintenance with an approved contractor.

- ▶ Have work carried out only by an approved contractor.
- ▶ Have the heating system inspected by an approved contractor at least once a year.
- ▶ Have any required cleaning or maintenance work carried out immediately.
- ▶ Have any defects in the heating system remedied immediately, independent of the annual inspection.

⚠ Fittings and modification

Only a competent engineer can remove the appliance case and carry out any work, in accordance with the relevant Installation Regulations.

Any misuse or unauthorised modifications to the appliance, flue or associated accessories and heating system will invalidate the guarantee.

- ▶ Do not modify the appliance or flue system in any way.

Bosch, Bosch Group accepts no liability arising from any such actions. This does not affect your statutory rights.

⚠ Combustion air/ambient air

The air in the installation location must be free of flammable or chemically aggressive substances.

- ▶ Do not store or use any flammable or explosive materials (paper, petrol, thinners, paints, etc.) in the vicinity of the heat source.
- ▶ Do not store or use any corrosive substances (solvents, adhesives, chlorinated cleaning agents, etc.) in the vicinity of the heat source.

⚠ General considerations

- ▶ The boiler must be installed in a well ventilated area. The openings must be kept in good condition.
- ▶ The vents or any other component contributing to the functioning of the boiler must not be reduced or sealed.
- ▶ We recommend an annual service of the appliance by an approved engineer to ensure reliable and efficient operation.

⚠ Safety of electrical devices for domestic use and similar purposes

The following requirements apply in accordance with EN 60335-1 in order to prevent hazards from occurring when using electrical appliances:

“This appliance can be used by children of 8 years and older, as well as by people with reduced physical, sensory or mental capabilities or lacking in experience and knowledge, if they are supervised and have been given instruction in the safe use of the appliance and understand the resulting dangers. Children shall not play with the appliance. Cleaning and user maintenance must not be performed by children without supervision.”

“If the power cable is damaged, it must be replaced by the manufacturer, its customer service department or a similarly qualified person, so that risks are avoided.”

⚠ Please read these instructions carefully

- ▶ These instructions are applicable to the Bosch appliance model/s stated on the front cover only.
- ▶ These instructions apply in the UK/IE only and must be followed except for any statutory obligation.

2 Product Information

2.1 Declaration of Conformity

2.1.1 Declaration of conformity

The design and operating characteristics of this product comply with the European and national requirements.

 The CE marking declares that the product complies with all the applicable EU legislation, which is stipulated by attaching this marking.

The complete text of the Declaration of Conformity is available on the Internet: worcester-bosch.ie.

2.1.2 Simplified EU Declaration of Conformity regarding radio equipment

Bosch Thermotechnik GmbH hereby declares, that the product Condens 8000 described in these instructions complies with the Directive 2014/53/EU.

The complete text of the EU Declaration of Conformity is available on the Internet: worcester-bosch.ie.

2.2 Appliance identification and serial number

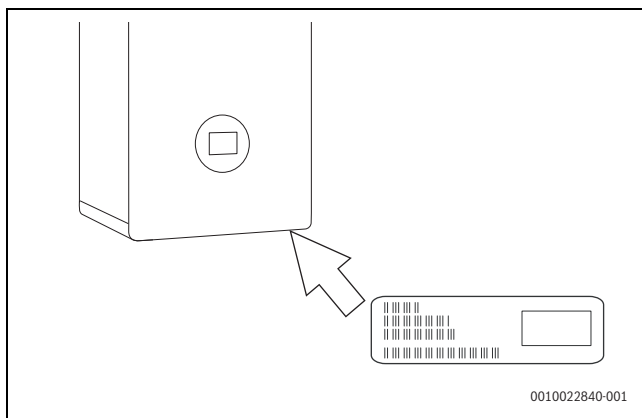

Fig. 1 Position of data label

The data label contains information of the appliance model and serial number. This is located on the frame of the front cover.

For your own records

Please ensure that the Commissioning Checklist has been completed by your installer or service engineer.

Model:	
Serial number:	
Date of installation:	

Table 2 Appliance details

The appliance model and serial number can be found on the appliance data label.

2.3 Servicing

 Ensure that the service engineer completes the Service Record in the Benchmark Checklist after each service.

The Service Record can be found at the rear of the appliance's Installation and Maintenance Instructions. It will be required in the event

of any guarantee work and may be required by the local Building Control Inspector.

- ▶ To ensure the continued safe, reliable and environmentally optimum operation of the boiler, it must be thoroughly serviced annually by a competent, qualified person, such as a Worcester service engineer, British Gas engineer or other Gas Safe registered engineer. In the Republic of Ireland servicing work must be carried out by a Worcester service engineer or other Registered Gas Installer (RGII).
 - Having a contract covering annual servicing, cleaning and maintenance is a good way to ensure this is not missed.
 - It is important that any required maintenance or repairs are carried out without delay.
- ▶ Ensure that the service engineer completes the Service Record, at the rear of the Installation and Maintenance Instructions manual, after each service.
- ▶ Have any work carried out by a competent, qualified person, Worcester service engineer, British Gas engineer or other Gas Safe registered engineer. In the Republic of Ireland servicing work must be carried out by a Worcester service engineer or other Registered Gas Installer (RGII).
- ▶ Always use original spares, to help maintain the efficiency, safety and reliability of the appliance.

2.4 Maintaining your appliance

Your new appliance represents a long term investment in a reliable, high quality product.

Wipe the appliance casing with a soft clean cloth. Please do not use chemical cleaning products which may damage the paint finish.

In order to realise the appliance's maximum working life, and to ensure the appliance continues to operate at peak efficiency and performance, it is essential that servicing and maintenance checks are performed at least once a year by a competent engineer in accordance with the current Gas Safe Regulations.

If you would like to know more about servicing options from Bosch, please visit www.worcester-bosch.ie

Please tick the appropriate box on your warranty registration card for further details of the Bosch Service Contract.

When your appliance requires servicing please contact a Bosch contact centre (see rear cover, appointments).

In addition to the service contract we are pleased to offer a one-off annual service or breakdown call out for your appliance.

Maintenance tips

- Appliances on a sealed heating system:
 - Regularly check the system pressure.
- Do not obstruct the flue outlet or the air inlet.
- Use in hard water areas:
 - In exceptionally hard water areas a device to prevent scale formation should be fitted. Installation of a salt based water softener should be in accordance with the requirements of the local water company. A bypass valve must be fitted and used to fill/top up the heating system with untreated water.

 **Important note:**

- ▶ If you have to add water regularly in your heating system, call a competent, qualified person.

2.5 Benchmark standard



The Benchmark initiative is a code of practice to encourage the correct installation, commissioning and servicing of domestic central heating appliances and system equipment.

A "checklist" is dispatched with every appliance and can be found towards the back of the Installation, Commissioning and Servicing Instructions. This is a vital document that needs to be completed by the installer at the time of installation. It confirms that the appliance has been installed and commissioned according to the manufacturer's instructions.

The service record provides space for the recording of regular servicing of the appliance/heating system and this can become a valuable document when, for example, you wish to sell the property. The service record will show a potential purchaser that the heating system has received regular professional maintenance and servicing during its lifetime.

The Benchmark initiative aims to:

- Raise standards among professional installers.
- Build and maintain high safety standards in the industry.
- Improve customer satisfaction levels.
- Make a contribution to the nation's commitment to climate change.

3 Prepare for operation

3.1 Sealed heating system

Appliances that can be connected to sealed heating systems are pre-pressurised before operation, this pressure must be maintained for safe use of the appliance.

- ▶ Check regularly that the pressure is maintained.
- ▶ Re-charge the system if the pressure indicator reads less than 0.8 bar.
- ▶ If a permanent significant decrease or increase in pressure is shown on the pressure indicator, contact your installer or maintenance engineer.



Pressure indicator

- ▶ Type of pressure indicator for the system pressure.
 - Pressure gauge (an analogue dial showing the pressure)
 - Pressure menu (a digital readout of the pressure)
- ▶ Your appliance may have one or both types of methods to indicate the system pressure. The type of method used on this appliance will be detailed in the following section.

3.1.1 Checking the system pressure

The appliance pressure menu indicates the pressure within the heating system during standby and operating periods.

Your installer will advise you of the optimum operating pressure.

- ▶ Check the system pressure on the pressure menu.
 - **Static pressure** is when appliance is cold and has not fired for heating or hot water. This will generally be 0.8 - 1.7 bar.
 - **Operating pressure** is when the appliance is firing for a heating or hot water demand. This will generally be 1 - 2 bar.

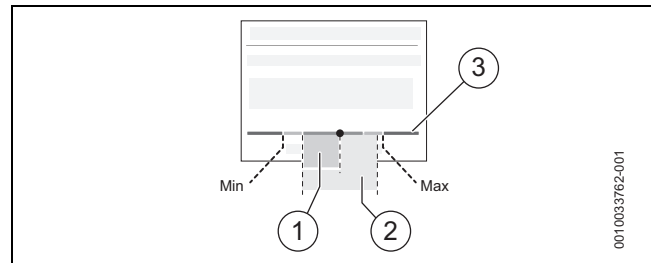

Fig. 2 Checking the operating pressure

- [1] Static pressure range.
- [2] Operating pressure range.
- [3] Pressure menu indicator.

The pressure menu can be accessed via the **Boiler status** screen.

- ▶ Press the menu key (≡). Select and confirm **Boiler status**. The screen **Boiler status** with a pressure menu indicator appears.
- ▶ Check the system pressure on the display.
 - **Indicator in red zone:** pressure is too low or too high.
 - **Indicator in yellow zone:** pressure is low or slightly too high.
 - **Indicator in green zone:** pressure is normal.
- ▶ Top up the heating water, if the pressure is low or too low.

3.1.2 Low pressure indication

Low pressure (shaded area [A]) will be indicated on the appliance:

- The pressure indicator is within the area between 0 and 0.79 bar in the pressure menu display (left hand yellow and red zone).
- Additionally there is a message displayed.

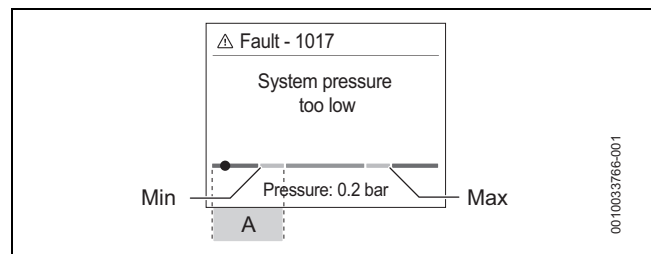

Fig. 3 Low pressure indication

- [A] Low pressure area

3.1.3 Constantly re-pressurising the system

Constantly having to re-pressurise the heating system should be investigated as it is an indicator of potential leaks and the concentration of inhibitor protection in the system will be reduced; this can result in corrosion within the heating system, reducing efficiency and increasing contaminates.

- ▶ Check for leaks on heating system (pipework and radiator valves).
- ▶ Contact your installer or maintenance engineer if a recurring significant decrease or increase in pressure is shown on the pressure indicator (pressure gauge or pressure display).

System pressure increasing:

- ▶ If the system pressure repeatedly increases and you need to vent air from the radiators, refer to → section 9.5 "System gassing troubleshooting", page 14.

3.2 Topping up the system pressure

Integral keyless filling link

Locate the filling link and follow the instructions for re-pressurising the system.

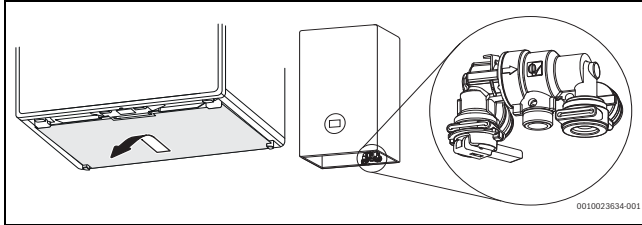

Fig. 4 Enable access to keyless filling link

- ▶ Re-pressurise the system.
 - Pull the lever [1] down to start the filling process.
 - The pressure indicator on the pressure display will start to move towards the green bar.
- ▶ When the pressure indicator reaches the middle of the green bar [2] and the pressure is between 1 and 1.5 bar
 - Release the lever [1] to stop the filling process.
- ▶ Top up the system pressure, if as a result of the air bleeding the pressure drops off.

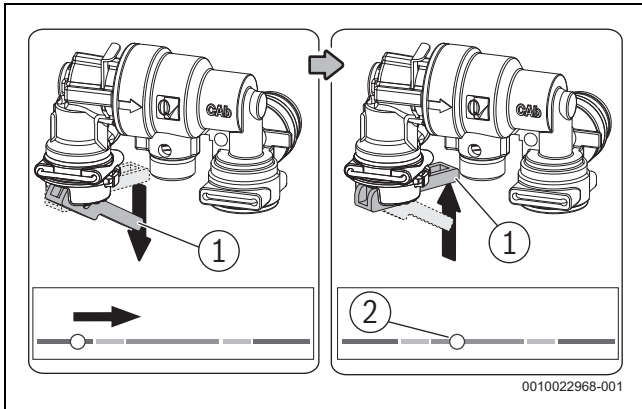

Fig. 5



If the indicator is on the right hand side red pressure zone as a result of over filling:

- ▶ Bleed one radiator until the pressure indicator returns to the green bar.

3.2.1 Greenstar Intelligent Filling System (accessory)

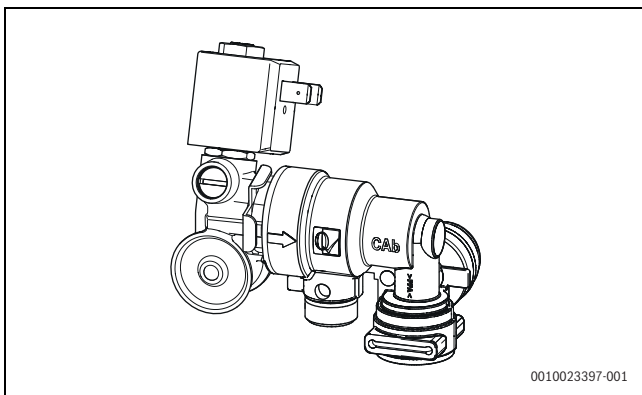

Fig. 6 Greenstar Intelligent Filling System



An Intelligent Filling System is available as an accessory.

The Intelligent Filling System refills the water into the heating system as required. Your specialist programmes the Intelligent Filling System according to your heating system. Have your specialist explain the function of the Intelligent Filling System to you.

Automatic refilling keeps the pressure in the heating system at the programmed value.

4 Operating the appliance

4.1 Control panel overview

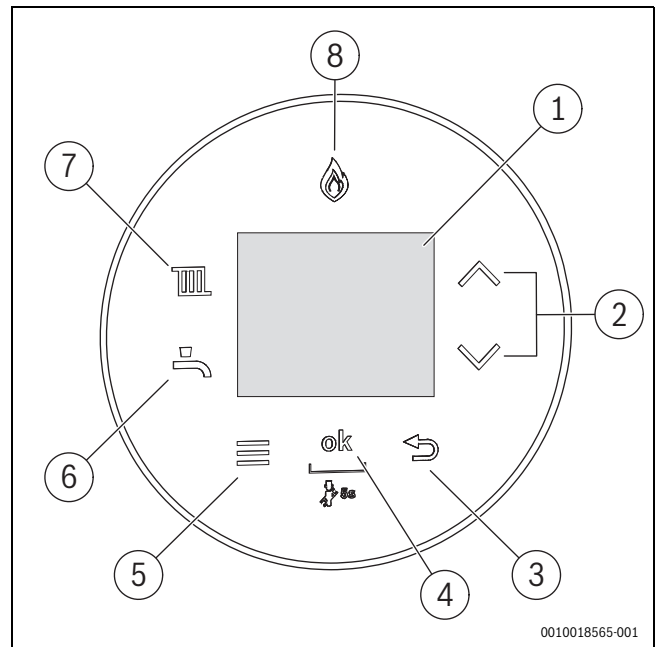

Fig. 7 Control panel

- [1] Display
- [2] ▲ and ▼ keys: To navigate through menus and increase/decrease settings
- [3] ↵ key: Return/back
- [4] ok key: Save settings
- [5] Menu key
- [6] Hot water key: Hot water mode on/off, adjusting the hot water temperature
- [7] Heating key: Heating mode on/off, set the maximum flow temperature
- [8] Burner display: Illuminates when the burner is alight.

4.2 Symbols in the display

Symbol	Explanation
	Connection with the Wi-Fi network (only available with accessories)
	Connection with RF transmitter, e.g. Comfort+ II RF room thermostat (only available with Key accessories)
	Central heating adjustment auto: Heating is switched on and off according to programmed times for heating . Advance: Move to the next on or off time and directly switch on or off heating.
	Central heating off
	Hot water adjustment eco: Hot water preheat off auto: Hot water is switched on and off according to programmed times for hot water . Once: Hot water heating on, from the first programmed switched-on time to the last programmed switch-off time.
	Hot water off
	Displays with the appliance status code and diagnostic code during a fault condition.
	Holiday symbol
	Cleaning mode to enables the boiler to be cleaned without making changes to the touch panel.
	Central heating or hot water can be switched either permanently on or off.
	Energy consumption ¹⁾
	Gas consumption kWh

1) The energy values shown are an estimation based on internal data of the appliance. Under real world conditions, many factors influence the energy consumption and the shown values will deviate from the values of an energy meter. The information is for indication only and should not be used for billing purposes. The values can be used for relative comparison of energy consumption between different days/weeks/month.

Table 3 Symbols in the display



The heating and hot water settings have been adjusted by the installer to the appliance's optimum settings.

- ▶ Before making any adjustments it is advisable to make a note of these settings so that you can return to these optimum settings in the future.

4.3 Adjusting the appliance flow temperature

4.3.1 Heating key



WARNING

Risk of scalding!

- ▶ This appliance is supplied with the CH control set at approximately 65 °C, a temperature that should be suitable for most installations that comply with current building regulations. When the boiler switches from CH to DHW, the temperature of the hot water may briefly exceed the DHW set point if the CH temperature is set higher than the DHW temperature. If the CH temperature is changed to above 65 °C, it is advisable to fit a thermostatic mixing valve (TMV) at the point of use (e.g. before the bath hot tap or shower) to protect vulnerable people from scalding.

The heating key is used to set the max. flow temperature. The maximum flow temperature can be set between 30 °C and 88 °C¹⁾. The current flow temperature is shown on the display.



With underfloor heating systems observe the maximum permissible flow temperature.

- ▶ Press the key. The set maximum flow temperature appears.
- ▶ Press the or keys to set the desired maximum flow temperature.

Supply temperature	Sample application
Approx. 50 °C	Underfloor heating system
Approx. 65 °C¹⁾	Radiator heating system

1) in certain cases, for example, where radiators are undersized or homes are poorly insulated, higher flow temperatures may be required. However, please refer to the relevant scalding risk advice in this manual

Table 4 Maximum flow temperature

- ▶ To save the setting, press the **ok** key or wait for 2 seconds. The symbol appears for a short time.



If a time program is activated and set on **S auto** press the **ok** key to switch to **S Advance**. Time programs are available with heating key (accessories).

S auto: Heating is switched on and off according to programmed times for heating.

S Advance: Switch to **S Advance** to move to the next on or off time and directly switch on or off heating.

1) The maximum value can be reduced by the service technician.

4.4 Hot water mode





4.4.1 Hot water key



WARNING

Risk of scalding!

▶ This appliance is supplied with the CH control set at approximately 65 °C, a temperature that should be suitable for most installations that comply with current building regulations. When the boiler switches from CH to DHW, the temperature of the hot water may briefly exceed the DHW set point if the CH temperature is set higher than the DHW temperature. If the CH temperature is changed to above 65 °C, it is advisable to fit a thermostatic mixing valve (TMV) at the point of use (e.g. before the bath hot tap or shower) to protect vulnerable people from scalding.

- ▶ Press the  key. The set hot water temperature appears.
- ▶ To set the desired hot water temperature, press the  or  keys.
- ▶ To save the setting, press the **ok** key or wait for 2 seconds. The symbol  appears for a short time.



If **DHW preheat** is **On**, press the **ok** key to switch between **Eco/Preheat**.

In **S Preheat** mode, the hot water heat exchanger is kept pre-heated to reduce the time taken to deliver hot water at the tap.

S Eco mode is an energy saving feature which disables the Preheat function. Eco mode is enabled by default, during the initial appliance start up.





Available with Key (accessories): If **DHW preheat** is on **Auto**, press the **ok** key to switch between **auto** and **S Advance**.

Auto: Hot water preheating is enabled during programmed times for hot water. The appliance is continually maintained at the set temperature.

S Advance: Switch to **S Advance** to move to the next on or off time and directly switch on hot water preheating.

4.5 Operating the menu





Opening and closing the menu

- ▶ To open the menu, press the  key.
- ▶ To exit the menu, press the  key again.

-or-

- ▶ Press the  key.

Changing the setting values

- ▶ To highlight a menu item, press the  key or the  key.
- ▶ Select the menu item with the **ok** key.
- ▶ To change the value, press the  or  key.
- ▶ Press the **ok** key. The new value is saved.

Exiting the menu without saving values

- ▶ Press the  key.

4.6 Settings in the menu



The factory settings are **highlighted** in the following table.

Menu item	Function definition
Heating mode ¹⁾	<ul style="list-style-type: none"> • On • Off • Auto: Activate time program. • Once: Heating is on from the first programmed on time to the last programmed off time without programmed intermissions.
Heat. time prog. ¹⁾	Timer for heating: Weekday(s) selection, day program and timer adjustment (→ "Time program", page 10)
DHW preheat	<ul style="list-style-type: none"> • On • Off • Auto¹⁾ • Once¹⁾
DHW time prog. ¹⁾	Timer for hot water: Weekday(s) selection, day program and timer adjustment (→ "Time program", page 10) ¹⁾
Boiler status	Screen with current system values including the pressure indicator.
Information	<p>The current system values and the active operating conditions can be called up in the Information menu. Changes are not possible.</p> <ul style="list-style-type: none"> • System pressure • Hot water Temp. (DHW temperature) • Weather comp. (weather-compensated control)¹⁾ • System Fill (automatic filling)²⁾ • Key (Type of installed key is shown, e.g. "Connect-Key") • Internet connect.
Energy consump.	<p>Display Gas consumption</p> <ul style="list-style-type: none"> • Last 24h • Last 30 days
Holiday ¹⁾	Start and end date of the holiday, activate and deactivate. Menu only visible if a time program is set.
Settings	<ul style="list-style-type: none"> • Time: Set the current time.¹⁾ • Date: Set the current date.¹⁾ • DST: enable automatic time shift change summer/winter time • Parental lock <ul style="list-style-type: none"> - On - Off • Display <ul style="list-style-type: none"> - Switch off after: Set the time after which the display is switched off. - Brightness: Set the display brightness. • Key illum. (Key illumination) • Language: Change the language of the menu and the menu items. • Units¹⁾
Cleaning funct.	No user operation is possible for 15 s. The display shows a countdown.

Menu item	Function definition
Emergency mode ³⁾	<ul style="list-style-type: none"> On: Set the desired heat flow temperature by pressing back or menu key after selecting On. Off
Start filling ²⁾	<ul style="list-style-type: none"> On <ul style="list-style-type: none"> Are you sure there is no leak in your heating system? Cancel now? Start filling Off

1) Only available with installed Key (accessories)

2) Only available with automatic filling facility (accessory)

3) Allows manual control of heating during loss of RF Key signal

Table 5 Settings Menu

5 Key (accessories)

5.1 Installing the Key



Installing the Key will enable additional functions. For Pairing → Key manual.

Always turn off the power to the appliance before installing Key (accessories).

- ▶ Plug Key into Key housing.

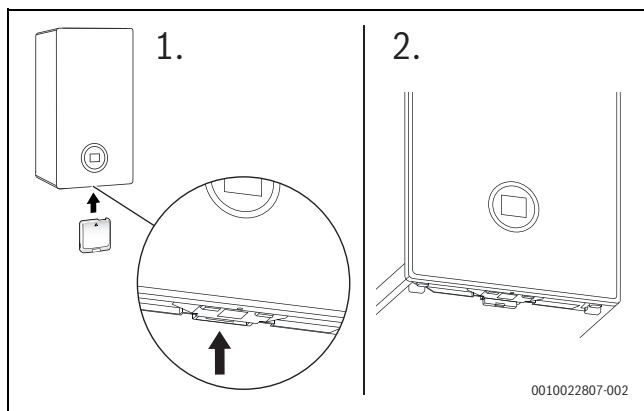

Fig. 8 Position of Key housing

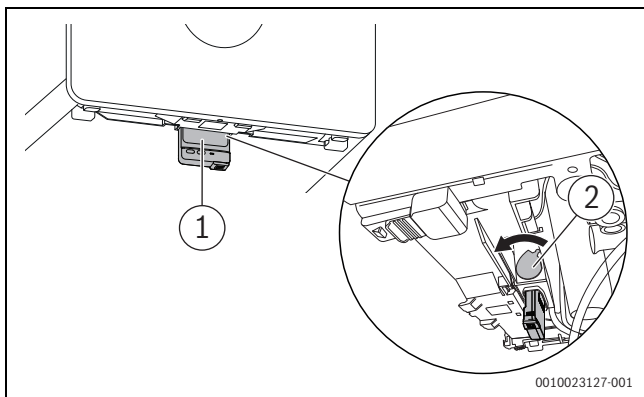

Fig. 9 Locking mechanism

- ▶ The lever [2] of the locking mechanism is located right hand side of the Key housing. Ensure that it is in its Open position before inserting the Key and pulling lever [2] towards front.
- ▶ Turn on the power.
LED [1] starts blinking green.

- ▶ Wait until LED is constantly yellow.

5.2 Key LED

Key LED status

The LED on the Key displays different states with flashing or constant colours.



Description of the LED displays	Example
Flashing red: Fault, e.g. no communication between the Key and appliance: ▶ Install the Key again, restore the last functioning status.	
Flashing yellow: No fault, user please wait.	
Flashing green: No fault, initialisation process is running.	
Constant red: Temporary fault: ▶ Wait for normal operating condition to be resumed.	
Constant yellow: No fault, time and date not available: ▶ Set the time and date on the appliance. -or- ▶ Key with touch-sensitive indicator: Press touch-sensitive indicator on Key to start pairing.	
Constant green: No fault, normal operating condition.	
LED Off: No fault, power-saving mode or appliance without power.	

Table 6 LED status

5.3 Setting the time program



Time program





The same method for setting the time program for heating is used to set the time program for hot water.

- ▶ Press the  key.
- ▶ Select and confirm the **Heat. time prog.** or **DHW time prog.** menu.
- ▶ Select and confirm the **Time program** menu.
The menu items **Mon - Fri**, **Sat - Sun**, **Mon ... Sun** are displayed.

Possible items to change:

- **Mon - Fri** to change switching times for all weekdays together
- **Mon ... Sun** to change switching times for individual days
- **Sat - Sun** to change switching times for weekends
- ▶ Select and confirm item you want to change.
- ▶ Select and confirm time entry you want to change.
- ▶ To change the time, press the  or  key.
- ▶ Press the **ok** key.
The new time is saved. Next time entry is selected.



Add one additional switching time block by selecting . Delete an existing switching time block by selecting .

6 Shutdown

6.1 Setting frost protection

NOTICE

Risk of damage to the system from frost!

The heating system can freeze up after a prolonged period (e.g. during a power failure, switching off the power supply, faulty fuel supply, boiler fault etc.).

- ▶ Ensure that the heating system is in constant use (particularly when there is a risk of frost).

If you are leaving your property unoccupied during cold weather, please leave your external programmer on constant and your room thermostat set to 12 °C.

7 Thermal disinfection

To prevent hot water from becoming contaminated by bacteria such as legionella, we recommend thermal disinfection after long downtimes.



CAUTION

Risk of scalding.

During thermal disinfection, discharging unmixed hot water can cause serious scalding.

- ▶ Only use the maximum adjustable hot water temperature for thermal disinfection.
- ▶ Inform occupants of the premises of the risk of scalding.
- ▶ Perform thermal disinfection outside of the normal operating times.
- ▶ Do not discharge DHW unmixed.

Proper thermal disinfection involves the DHW system including the draw-off points.

- ▶ Set the thermal disinfection in the hot water program of the heating controller (→ heating controller operating instructions).
- ▶ Close DHW draw-off points.
- ▶ Set any DHW circulation pump to continuous operation.
- ▶ Wait until the maximum temperature is reached.
- ▶ Open all DHW draw-off points, from the nearest to the one furthest away, and draw off hot water until hot water at a minimum of 70 °C has flown from all draw-off points for at least 3 minutes.
- ▶ Restore the original settings.

8 Clearances and ventilation information

8.1 Appliance clearances

Your installer will have provided adequate space around the appliance for operation, safety and servicing/maintenance access.

- The following detail the necessary clearance around the appliance for service and maintenance.



CAUTION

Risk of damage to appliance or property

The appliance will overheat if the clearance space around the appliance is restricted by objects.

- ▶ Do not restrict this space with the addition of cupboards, shelves etc. next to or around the appliance.
- ▶ Do not store any combustible materials on or next to the appliance, such as clothes, towels, paper or plastic bags.

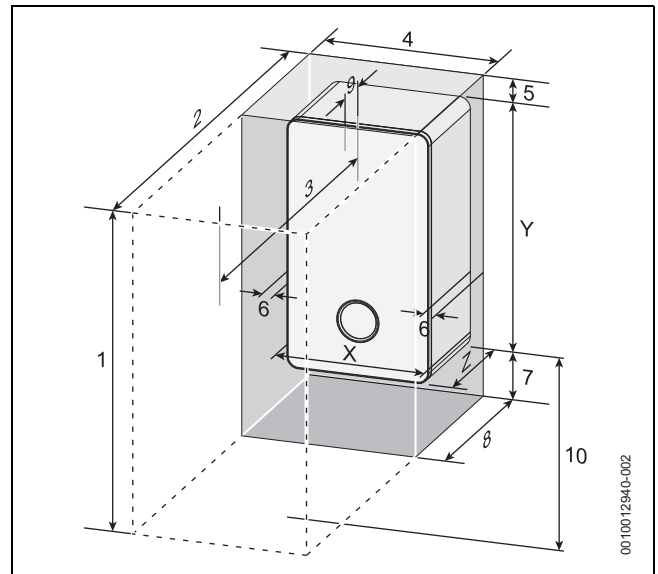

Fig. 10 Appliance minimum clearances

Minimum clearances		
	Description	Dimensions [mm]
X	Appliance width	440
Y	Appliance height	780
Z	Appliance depth	365
Installation/Maintenance		
1	Overall clearance height	1,150/1,190*
2	Overall clearance depth	965
3	In front of appliance	450
4	Overall clearance width	450
5	Above the appliance	170/210*
6	Either side of appliance	5
7	Below the appliance	200
8	Compartment depth	385
9	Appliance to removable door	20
10	Min clearance to the floor	400

Table 7

[*] Height for either 60/100 flue or 80/125 flue

8.2 Ventilation information

The air supply must not be restricted or contaminated.



Ventilation considerations

- ▶ Do not place objects to hinder the air circulation required by the appliance.
- ▶ The installation premises may require ventilation to be fitted according to its features or use.

9 Malfunction or failure

If you believe there is a problem with your central heating or hot water supply, before you contact your installer/maintenance engineer and report the error and appliance type carry out the following checks.

Basic checks

Some items to check before placing a call are:

- Is the electrical power switched on to the appliance?
- Is the programmer/timer set to ON or in an ON period?
- Is the room thermostat set too low?
- Is the cylinder thermostat (if fitted) set too low?
- Is the cold water main turned on?
- Sealed heating system:
 - Is the static system pressure (when appliance is cold) between 1 and 1.5 bar?
- Do you have gas?
 - Are other gas appliances working, gas cooker/hob for example?
 - Has your credit run out on your gas pre-payment meter?

Details of your installer should be available in the Commissioning Checklist or can be recorded in the following section.

Installer/maintenance engineer

Installer/maintenance engineer details	
Engineer name:	
Company name:	
Company address:	
Telephone:	
Email:	

Table 8

Bosch

The appliance is supported in EIRE by Bosch.

Specialist service engineers are available to attend an appliance breakdown.



Invoices for attendance and repair work carried out on this appliance by any third party will not be accepted.

- No charge will be made for parts and/or labour providing:
 - The appliance fault is found and the appliance is within the guarantee period. Reasonable evidence of this must be supplied on request. i.e. a completed Commissioning and service record and has been regularly serviced at least once a year.
- A call-out charge will be made where:
 - The appliance is outside the guarantee period or has not been serviced in accordance with the manufacturers instructions.
 - Our Field Service Engineer finds no fault with the appliance.
 - The cause of breakdown is misuse or with other parts of your plumbing/heating system, or with equipment not supplied by Bosch.



No appliance fault is found on over 30% of all service calls.

- ▶ In the case of a suspected fault, refer to the basic checks earlier in this section.

In the event of an appliance fault or breakdown please contact Bosch appointments team on 0330 123 9339. Your advisor will arrange for an engineer to call with the minimum of delay; under normal circumstances this will be from 1–3 working days (excluding weekends and bank holidays) for priority breakdown situations (no hot water and/or heating).

9.1 Troubleshooting (fault reset)

If there is fault in the system, there will be a message shown on the display with an icon on the right up corner. The color of this icon depends on the severity of the fault in the system. The cause of the fault is coded (e.g. fault code 232) and displayed as text.

- ▶ Press the ▲ and ▼ keys until **Reset** is displayed. The appliance starts up again and the current supply temperature is displayed.

If a fault persists:

- ▶ Contact the contractor or the customer service.
- ▶ Provide them with the displayed fault code and the device data (→ table 5).

9.2 Fault 2980



CAUTION

Fault 2980

- ▶ If fault 2980 is visible on the boiler display then contact a qualified heating engineer immediately. Do not attempt to remedy the fault otherwise there is a chance this could lead to a serious, safety-related fault. Heating and hot water will not be available until remedied by a qualified heating engineer.

9.3 Troubleshooting

If there is fault in the system, there will be a message shown on the display. The cause of the fault is coded (e.g. fault code 232).

- ▶ Press the ▲ and ▼ keys together until fault disappears. The appliance starts up again and the current supply temperature is displayed.

If a fault persists:

- ▶ Contact the contractor or the customer service.
- ▶ Provide them with the displayed fault code and the device data (→ table 2).

9.4 Extreme cold weather

In certain instances where the condensate pipework is run externally or in an unheated area, such as a garage, the condensate pipework can be at risk of freezing, even if well insulated.

A frozen/blocked condensate pipe will cause the boiler to shut down. Bosch have available helpful videos on thawing frozen condensate pipe work on our website in the Customer Service section.



WARNING

Falling hazard!

Failure to follow this guidance may result in personal injury.

- ▶ Only attempt to thaw a condensate pipe that is at ground level and easily accessible.
- ▶ Never attempt to thaw a condensate pipe that is at height.



CAUTION

Risk of damage to pipe work!

Thermal shock from boiling water can damage plastic pipes.

- ▶ **DO NOT** use boiling water to thaw the condensate pipe!



CAUTION

Slip hazard

- ▶ Ensure that the subsequent freezing of any water does not result in a slip hazard.

If the condensate pipe has frozen:

- ▶ Locate the blockage.
 - It is likely that the pipe is frozen at the most exposed point outside the building or where there is an obstruction to flow. This could be the open end of the pipe, at a bend or elbow, or where there is a sag in the pipe in which condensate can collect.
 - The location of the blockage should be identified as closely as possible before taking further action.
- ▶ Thaw the frozen pipe.
 - The pipe can be thawed by applying a hot water bottle, a microwaveable heating pack (the sort used for muscular aches and pains) or a cloth soaked in hot water to the exterior of the pipe, close to the point of blockage.
 - Hot water, but not boiling, can also be poured onto the pipe from a watering can or similar container.
 - Care must be taken at pedestrian areas where this water may freeze and create a slip hazard.
- ▶ Bosch have available on our website helpful videos in the Customer Service section to aid in thawing a frozen pipe.
- ▶ Reset the appliance and wait two or three minutes for the appliance to restart.
- ▶ Contact Bosch Appointments Team on: 0330 123 9339, if the boiler does not restart.
- ▶ Contact your installer in order to find a permanent solution to the problem.

9.5 System gassing troubleshooting

 **WARNING**

Caution must be exercised when venting radiators or adjusting system pressure after commissioning of your boiler.

Do not repeatedly vent your radiators, if symptoms persist, contact a heating engineer.

- ▶ Do not vent air from radiators whilst the central heating is switched on; turn your boiler off.
- ▶ Whilst venting radiators, do not allow the pressure on the boiler to drop below the pressure at which it is normally set.

 **CAUTION**

If the pressure in your heating system is repeatedly rising (this can be checked via the boilers pressure gauge or digital display and should be checked when the system is cold), and especially if you need to keep venting the radiators, urgent action is required and you must contact a heating engineer. This can indicate that there is corrosion occurring within the heating system

Note: Ensure the reading stays between minimum and maximum operating pressures at all times whilst the boiler is operating

- ▶ This must be properly addressed to prevent serious damage to the entire system.
- ▶ Failure to properly maintain the heating system may affect your warranty.

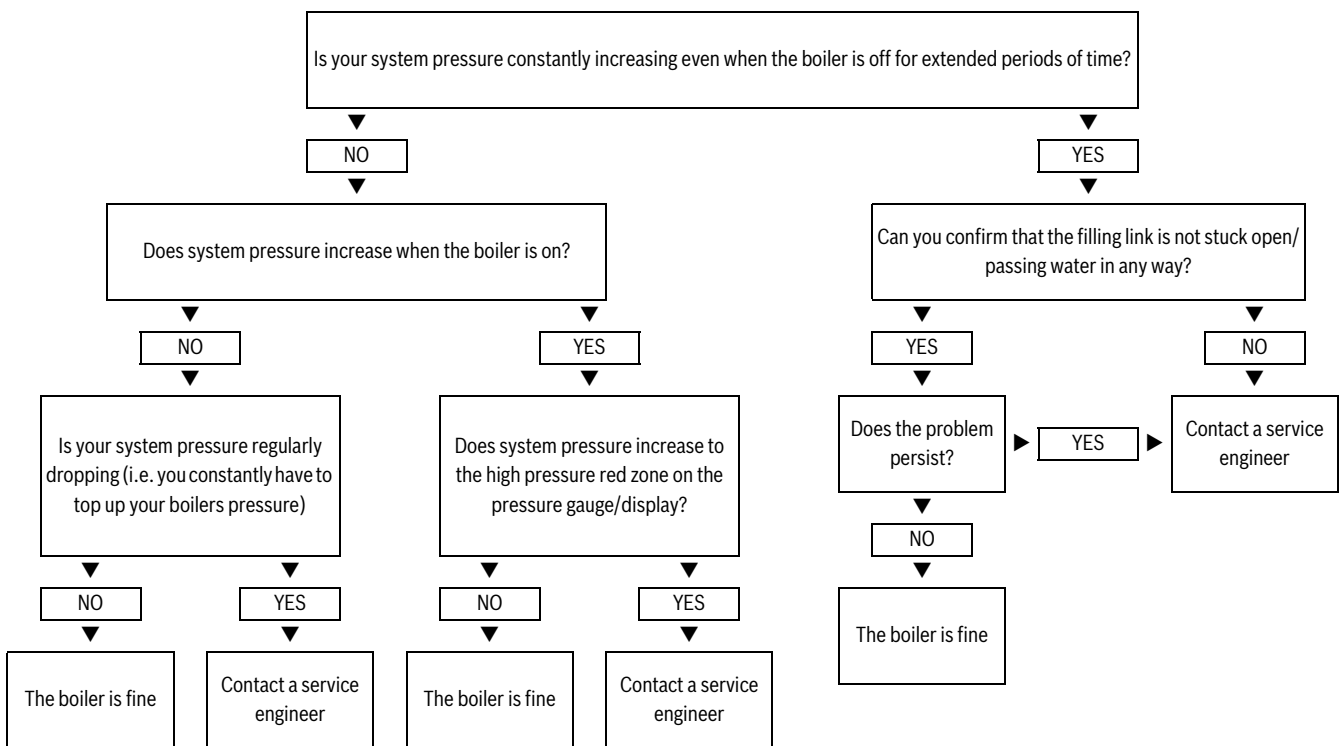

Table 9 System gassing flow chart

10 Environmental protection and disposal

Environmental protection is a fundamental corporate strategy of the Bosch Group.

The quality of our products, their economy and environmental safety are all of equal importance to us and all environmental protection legislation and regulations are strictly observed.

We use the best possible technology and materials for protecting the environment taking account of economic considerations.

Packaging

Where packaging is concerned, we participate in country-specific recycling processes that ensure optimum recycling.

All of our packaging materials are environmentally compatible and can be recycled.

Used appliances

Used appliances contain valuable materials that can be recycled.

The various assemblies can be easily dismantled. Synthetic materials are marked accordingly. Assemblies can therefore be sorted by composition and passed on for recycling or disposal.

Old electrical and electronic appliances



This symbol means that the product must not be disposed of with other waste, and instead must be taken to the waste collection points for treatment, collection, recycling and disposal.

The symbol is valid in countries where waste electrical and electronic equipment regulations apply, e.g. "(UK) Waste Electrical and Electronic Equipment Regulations 2013 (as amended)". These regulations define the framework for the return and recycling of old electronic appliances that apply in each country.

As electronic devices may contain hazardous substances, it needs to be recycled responsibly in order to minimize any potential harm to the environment and human health. Furthermore, recycling of electronic scrap helps preserve natural resources.

For additional information on the environmentally compatible disposal of old electrical and electronic appliances, please contact the relevant local authorities, your household waste disposal service or the retailer where you purchased the product.

You can find more information here:

www.bosch-homecomfortgroup.com/en/company/legal-topics/weee/

Batteries

Batteries must not be disposed together with your household waste. Used batteries must be disposed of in local collection systems.

11 Data Protection Notice



We, **Bosch Thermotechnology Ltd., Cotswold Way, Warndon, Worcester WR4 9SW, United Kingdom**

process product and installation information, technical and connection data, communication data, product registration and client history data to provide product functionality (art. 6 (1) sentence 1 (b) GDPR

/ UK GDPR), to fulfil our duty of product surveillance and for product safety and security reasons (art. 6 (1) sentence 1 (f) GDPR / UK GDPR), to safeguard our rights in connection with warranty and product registration questions (art. 6 (1) sentence 1 (f) GDPR / UK GDPR) and to analyze the distribution of our products and to provide individualized information and offers related to the product (art. 6 (1) sentence 1 (f) GDPR / UK GDPR). To provide services such as sales and marketing services, contract management, payment handling, programming, data hosting and hotline services we can commission and transfer data to external service providers and/or Bosch affiliated enterprises. In some cases, but only if appropriate data protection is ensured, personal data might be transferred to recipients located outside of the European Economic Area and the United Kingdom. Further information are provided on request. You can contact our Data Protection Officer under: Data Protection Officer, Information Security and Privacy (C/ISP), Robert Bosch GmbH, Postfach 30 02 20, 70442 Stuttgart, GERMANY.

You have the right to object, on grounds relating to your particular situation or where personal data are processed for direct marketing purposes, at any time to processing of your personal data which is based on art. 6 (1) sentence 1 (f) GDPR / UK GDPR. To exercise your rights, please contact us via privacy.ttgb@bosch.com To find further information, please follow the QR-Code.

12 Tips on energy saving

Heating economically

The appliance provides a high level of comfort whilst keeping fuel consumption and the environment effects as low as possible.

The appliance is controlled in such a way that it delivers heat at the correct rate and only if there is a clear demand from the system.

Central heating systems with thermostatic radiator valves

With modern heating systems set around a 20 °C heat loss, the optimum setting for a condensing boiler will be approximately 65 °C for the central heating temperature. This is to ensure a return temperature of less than 52 °C.

The system must be balanced correctly and the radiators may need upgrading. This allows the boiler to condense as much as possible for the central heating system.

The temperature of each room can be set individually (except primary room with the room thermostat) using the thermostatic radiator valves.

Room thermostats

Reducing the setting of the room thermostat by 1 °C can reduce fuel consumption by up to 10%.

New control systems

Upgrade your heating control system if necessary with the latest equipment available.

Roof insulation

Around 30% of the heat loss from a property is through the roof. Replace any old insulation with new insulation, preferably of around 200mm thickness or more.

Window frames

Single glazed windows, particularly those with steel frames, can lose a great deal of heat. Consideration should be given to replacement with PVCu or wooden framed double glazed units.

Radiators

If a radiator is sited underneath a window, its performance will be affected if the curtains are allowed to drape over the radiator. Shelves fitted above or in front of the radiator should also be avoided.

It is advisable to manually adjust all thermostatic radiator valves every 2–3 months to prevent them sticking. Ensure radiator valves are correctly set and not damaged.

Draughts

Try to ensure that draughts around doors, windows, letter boxes and keyholes etc. are reduced by using a suitable draught excluder.



WARNING

Air vents!

- ▶ Do not block or seal any air vents that are installed to ensure that the appliance operates safely.

Curtains

Lined curtains, or heavier full length curtains can provide excellent insulation. However, always ensure that the curtains do not drape over radiators.

13 Your guarantee

This appliance has a guarantee against faulty materials or workmanship from the date of installation subject to the following terms and conditions:

- During the period of this guarantee any components of the appliance that are proven to be faulty or defective in manufacture will be

exchanged or repaired free of charge by Bosch Thermotechnology Ltd.

- The householder may be asked to prove the date of installation, that the appliance was correctly commissioned and, where appropriate, serviced to the satisfaction of Bosch Thermotechnology Ltd. These should be documented in the commissioning and service records in the Installation and Maintenance Instructions.
- The appliance has been used only for the normal domestic purposes for which it was designed.

This guarantee does not affect your statutory rights.

Guarantee registration

Your appliance/product carries a guarantee against faulty material or manufacture subject to Terms and Conditions.

To read the full Terms & Conditions please visit us on-line at www.worcester-bosch.ie/guarantee.

Your statutory rights are not affected by the manufacturer's guarantee

14 Energy consumption

The maximum heat output of this boiler can be adjusted to suit the exact requirements of the building. The process of adjusting the maximum heat output is commonly referred to as range rating. The new boiler is set at the maximum output and should be adjusted when it is installed and commissioned. In accordance with the standards, the declared space

heating efficiency, useful efficiency and NO_x values efficiency for this range rated boiler are not measured at the maximum output. To achieve the published efficiency and NO_x values, the gas rate should be reduced by your installer during commissioning (→ Installation and Maintenance instructions).

14.1 Product data on energy consumption

The information provided fulfills the requirements of regulations (EU) 811/2013 and (EU) 813/2013.

Specific precautions for installation, maintenance as well as recycling and/or disposal are provided within the installation and operating manuals. Read and follow the installation and operating manuals.

Product data	Symbol	Unit	7736702604	7736702605
Product type	-	-	GC8700iW 33/36 C	GC8700iW 33/40 C
Energy Efficiency Class	-	-	A	A
Range rated heat output	P _{rated}	kW	36	40
Seasonal space heating energy efficiency at range rated output	η _s	%	94	94
Annual energy consumption (average climate conditions)	Q _{HE}	kWh	--	--
Annual energy consumption	Q _{HE}	GJ	78	78
Sound power level, indoors	L _{WA}	dB	53	55
Special precautions to be taken during assembly, installation or maintenance (if applicable)	-	-	→ product accompanying documents	
Condensing boiler	-	-	Yes	Yes
Low temperature boiler	-	-	No	No
B1 boiler	-	-	No	No
Cogeneration space heater	-	-	No	No
Combination heater	-	-	No	No
Useful heat output				
At rated heat output and high temperature regime	P ₄	kW	33.7	33.7
At 30% of rated heat output and low temperature regime	P ₁	kW	11.3	11.3
Useful efficiency				
At rated heat output and high temperature regime	η ₄	%	88.8	88.8
At 30% of rated heat output and low temperature regime	η ₁	%	98.8	98.8
Auxiliary electricity consumption				
At full load	e _{l,max}	kW	0.048	0.048
At part load	e _{l,min}	kW	0.013	0.013
In standby mode	P _{SB}	kW	0.001	0.001
Other items				
Standby heat loss	P _{stby}	kW	0.071	0.071
Ignition burner power consumption	P _{ign}	kWh	-	-
Emissions of nitrogen oxides (only gas- or oil fired) at range rated output	NO _x	mg/kWh	25	25
Additional data for combination heaters				
Daily electricity consumption (average climate conditions)	Q _{elec}	kWh	0.168	0.177
Daily fuel consumption	Q _{fuel}	kWh	22.174	22.656

Table 10 Product data on energy consumption Condens 8000

15 Open Source Software

15.1 List of used Open Source Components

This document contains a list of open source software (OSS) components used within the product under the terms of the respective licenses. The source code corresponding to the open source components is also provided along with the product wherever mandated by the respective OSS license.

Name of OSS Component	Version of OSS Component	Name and Version of License (License text can be found in Appendix below)	More Information
STM32 cube generated files	Unspecified	BSD (Three Clause License) (→ Kap. 15.3)	Copyright © 2016 STMicroelectronics Copyright © 2014 STMicroelectronics
STMC4Lib-IAR	Unspecified	BSD (Three Clause License) (→ Kap. 15.3)	Copyright © 2009 - 2015 ARM LIMITED Copyright © 2016 STMicroelectronics
stm32f30x	Unspecified	MCD-ST Liberty Software License Agreement v2 (→ Kap. 15.3)	Copyright © 2012 STMicroelectronics

Table 11

Provided that within certain OSS-Licenses (e.g. LGPL-2.0) necessary, reverse-engineering is allowed for the respective software component to the required extent. This shall not apply for other components of the software.

15.2 Used Commercial Source Components

15.2.1 This product contains software developed and licensed by SEGGER Software GmbH

15.3 Appendix - License Text

15.3.1 BSD (Three Clause License)

Redistribution and use in source and binary forms, with or without modification, are permitted provided that the following conditions are met:

- ▶ Redistributions of source code must retain the above copyright notice, this list of conditions and the following disclaimer.
- ▶ Redistributions in binary form must reproduce the above copyright notice, this list of conditions and the following disclaimer in the documentation and/or other materials provided with the distribution.
- ▶ Neither the name of the <ORGANIZATION> nor the names of its contributors may be used to endorse or promote products derived from this software without specific prior written permission.

THIS SOFTWARE IS PROVIDED BY THE COPYRIGHT HOLDERS AND CONTRIBUTORS "AS IS" AND ANY EXPRESS OR IMPLIED WARRANTIES, INCLUDING, BUT NOT LIMITED TO, THE IMPLIED WARRANTIES OF MERCHANTABILITY AND FITNESS FOR A PARTICULAR PURPOSE ARE DISCLAIMED. IN NO EVENT SHALL THE COPYRIGHT HOLDER OR CONTRIBUTORS BE LIABLE FOR ANY DIRECT, INDIRECT, INCIDENTAL, SPECIAL, EXEMPLARY, OR CONSEQUENTIAL DAMAGES (INCLUDING, BUT NOT LIMITED TO, PROCUREMENT OF SUBSTITUTE GOODS OR SERVICES; LOSS OF USE, DATA, OR PROFITS; OR BUSINESS INTERRUPTION) HOWEVER CAUSED AND ON ANY THEORY OF LIABILITY, WHETHER IN CONTRACT, STRICT LIABILITY, OR TORT (INCLUDING NEGLIGENCE OR OTHERWISE) ARISING IN ANY WAY OUT

OF THE USE OF THIS SOFTWARE, EVEN IF ADVISED OF THE POSSIBILITY OF SUCH DAMAGE.

15.3.2 MCD-ST Liberty Software License Agreement v2

SLA0044 Rev5/February 2018

BY INSTALLING COPYING, DOWNLOADING, ACCESSING OR OTHERWISE USING THIS SOFTWARE OR ANY PART THEREOF (AND THE RELATED DOCUMENTATION) FROM STMICROELECTRONICS INTERNATIONAL N.V, SWISS BRANCH AND/OR ITS AFFILIATED COMPANIES (STMICROELECTRONICS), THE RECIPIENT, ON BEHALF OF HIMSELF OR HERSELF, OR ON BEHALF OF ANY ENTITY BY WHICH SUCH RECIPIENT IS EMPLOYED AND/OR ENGAGED AGREES TO BE BOUND BY THIS SOFTWARE LICENSE AGREEMENT.

Under STMicroelectronics' intellectual property rights, the redistribution, reproduction and use in source and binary forms of the software or any part thereof, with or without modification, are permitted provided that the following conditions are met:

1. Redistribution of source code (modified or not) must retain any copyright notice, this list of conditions and the disclaimer set forth below as items 10 and 11.
2. Redistributions in binary form, except as embedded into microcontroller or microprocessor device manufactured by or for STMicroelectronics or a software update for such device, must reproduce any copyright notice provided with the binary code, this list of conditions, and the disclaimer set forth below as items 10 and 11, in documentation and/or other materials provided with the distribution.
3. Neither the name of STMicroelectronics nor the names of other contributors to this software may be used to endorse or promote products derived from this software or part thereof without specific written permission.
4. This software or any part thereof, including modifications and/or derivative works of this software, must be used and execute solely and exclusively on or in combination with a microcontroller or microprocessor device manufactured by or for STMicroelectronics.
5. No use, reproduction or redistribution of this software partially or totally may be done in any manner that would subject this software to any Open Source Terms. "Open Source Terms" shall mean any open source license which requires as part of distribution of software that the source code of such software is distributed therewith or otherwise made available, or open source license that substantially complies with the Open Source definition specified at www.opensource.org and any other comparable open source license such as for example GNU General Public License (GPL), Eclipse Public License (EPL), Apache Software License, BSD license or MIT license.
6. STMicroelectronics has no obligation to provide any maintenance, support or updates for the software.
7. The software is and will remain the exclusive property of STMicroelectronics and its licensors. The recipient will not take any action that jeopardizes STMicroelectronics and its licensors' proprietary rights or acquire any rights in the software, except the limited rights specified hereunder.
8. The recipient shall comply with all applicable laws and regulations affecting the use of the software or any part thereof including any applicable export control law or regulation.
9. Redistribution and use of this software or any part thereof other than as permitted under this license is void and will automatically terminate your rights under this license.
10. THIS SOFTWARE IS PROVIDED BY STMICROELECTRONICS AND CONTRIBUTORS "AS IS" AND ANY EXPRESS, IMPLIED OR STATUTORY WARRANTIES, INCLUDING, BUT NOT LIMITED TO, THE IMPLIED WARRANTIES OF MERCHANTABILITY, FITNESS FOR A PARTICULAR PURPOSE AND NON-INFRINGEMENT OF THIRD PARTY INTELLECTUAL PROPERTY RIGHTS, WHICH ARE DISCLAIMED TO

THE FULLEST EXTENT PERMITTED BY LAW. IN NO EVENT SHALL STMICROELECTRONICS OR CONTRIBUTORS BE LIABLE FOR ANY DIRECT, INDIRECT, INCIDENTAL, SPECIAL, EXEMPLARY, OR CONSEQUENTIAL DAMAGES (INCLUDING, BUT NOT LIMITED TO, PROCUREMENT OF SUBSTITUTE GOODS OR SERVICES; LOSS OF USE, DATA, OR PROFITS; OR BUSINESS INTERRUPTION) HOWEVER CAUSED AND ON ANY THEORY OF LIABILITY, WHETHER IN CONTRACT, STRICT LIABILITY, OR TORT (INCLUDING NEGLIGENCE OR OTHERWISE) ARISING IN ANY WAY OUT OF THE USE OF THIS SOFTWARE, EVEN IF ADVISED OF THE POSSIBILITY OF SUCH DAMAGE.

11. EXCEPT AS EXPRESSLY PERMITTED HEREUNDER, NO LICENSE OR OTHER RIGHTS, WHETHER EXPRESS OR IMPLIED, ARE GRANTED UNDER ANY PATENT OR OTHER INTELLECTUAL PROPERTY RIGHTS OF STMICROELECTRONICS OR ANY THIRD PARTY.

TECHNICAL SUPPORT:	0330 123 3366
RENEWABLE SUPPORT:	0330 123 9229
CONTROLS AND CONNECTIVITY TEAM:	0330 123 3641
APPOINTMENTS:	0330 123 9339
SPARES:	0330 123 9779
LITERATURE:	0330 123 9119
TRAINING:	0330 123 0166
SALES:	0330 123 9669

Bosch Thermotechnik GmbH
Junkersstrasse 20-24
73249 Wernau
Germany
worcester-bosch.ie