

User Instructions and Customer Care Guide

Floor standing oil fired condensing boiler conventional flue and room sealed flue

Greenstar Danesmoor Kitchen Regular and Kitchen System 12/18, 18/25, & 25/32

For fully pumped open vent and sealed central heating systems and domestic hot water cylinders

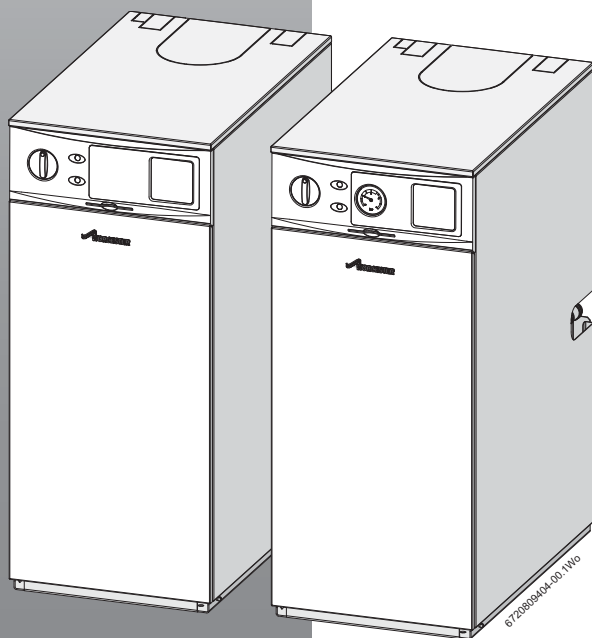

UK

Contents

1	Key to symbols and safety instructions	3
1.1	Key to symbols	3
1.2	General safety instructions	3
2	Using your boiler	4
2.1	Controls	4
2.2	Operating the boiler	5
2.2.1	Switching the boiler on/off	5
2.2.2	Setting the heating temperature	5
2.2.3	Controlling the central heating	5
2.2.4	Frost protection	5
2.2.5	Fault conditions	6
2.2.6	Fault finding	7
3	Maintenance	8
3.1	Maintaining your boiler	8
3.2	Servicing	8
4	External filling loop (Sealed system only)	9
5	General information	10
5.1	Ventilation information	10
5.2	Maintenance clearances	10
5.3	General notes	10
6	Energy saving	11
6.1	Tips on energy saving	11
7	Guarantee	12
7.1	Fault or breakdown	12
7.2	Guarantee registration	13

1 Key to symbols and safety instructions

1.1 Key to symbols

Warnings

	<p>Warnings in this document are identified by a warning triangle printed against a grey background.</p> <p>Keywords at the start of a warning indicate the type and seriousness of the ensuing risk if measures to prevent the risk are not taken.</p>
--	---

The following keywords are defined and can be used in this document:

- **NOTICE** indicates a situation that could result in damage to property or equipment.
- **CAUTION** indicates a situation that could result in minor to medium injury.
- **WARNING** indicates a situation that could result in severe injury or death.
- **DANGER** indicates a situation that will result in severe injury or death.

Important information

	<p>This symbol indicates important information where there is no risk to people or property.</p>
--	--

Additional symbols

Symbol	Explanation
▶	Step in an action sequence
→	Cross-reference to another part of the document
•	List entry
–	List entry (second level)

1.2 General safety instructions

These operating instructions are intended for the user of the heating system.

- ▶ Read any operating instructions (boiler, heating controls, etc.) carefully before operation and keep them.
- ▶ Observe the safety instructions and warnings.

Oil fumes or leaks from the appliance

If you smell oil fumes, observe the following rules.

- ▶ Extinguish any naked flames
- ▶ Isolate the electrical supply
- ▶ Isolate the fuel supply to the boiler
- ▶ Open windows and doors
- ▶ Rectify the fault

Health and safety

The appliance contains no asbestos and no substances have been used in the construction process that contravene the COSHH Regulations (Control of Substances Hazardous to Health Regulations 1988). Where applicable, the CE mark indicates compliance with relative EU Directives.

Combustion air/room air

The air in the installation room must be free of combustible or chemically aggressive substances.

- ▶ Do not use or store combustible or explosive materials (paper, propellants, thinners, paints, etc.) within the vicinity of the appliance.
- ▶ Do not use or store corrosive substances (solvents, adhesives, chlorinated cleaning agents, etc.) within the vicinity of the appliance.

Intended use

This boiler must only be used as a heat appliance in a sealed hot water heating system for domestic purposes.

Any other use is considered inappropriate. Any damage that results from such use is excluded from liability.

Boiler operation

This boiler must only be operated by a responsible adult who has been instructed in, understands, and is aware of the boiler's operating conditions and effects.

Servicing

The Service Checklist can be found at the rear of the boiler's installation instructions. It will be required in the event of any guarantee work and may be required by the local Building Control Inspector.

- ▶ Have the boiler serviced regularly by a competent, OFTEC registered engineer.
- ▶ Ensure that the service engineer completes the Service Record, at the rear of the Installation, Commissioning and Servicing Instruction manual, after each service.

Modifications and repairs

Unprofessional modifications to the boiler or other parts of the heating system can result in injury and/or damage to property or equipment.

- ▶ Have any work carried out only by a competent, OFTEC registered engineer.
- ▶ Do not remove the boiler case.
- ▶ Do not modify the boiler or other parts of the heating system in any way.

2 Using your boiler

2.1 Controls

1. Temperature control
2. Heating demand indicator
3. Lockout indicator
4. Pressure gauge (Kitchen System only)
5. Position for option internal programmer
6. Front panel
7. Reset button - Boiler overhear thermostat (behind front panel [6])
8. Slot for quick reference guide
9. Reset button - Flue overhear thermostat (behind front panel [6])
10. Lockout reset button on burner control box (behind front panel [6])

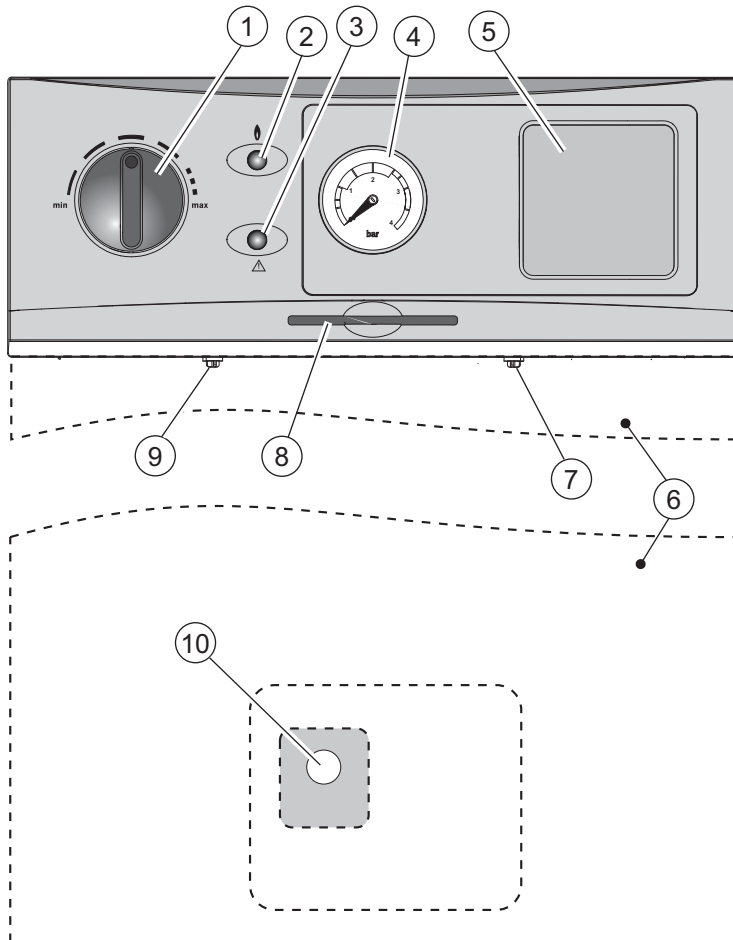

6720809404-01.1W6

2.2 Operating the boiler

2.2.1 Switching the boiler on/off

- ▶ To switch on the boiler; turn on the water, oil and electricity supply to the boiler.
- ▶ Check the programmer/timer is correct and is set to ON.
- ▶ Set the room thermostat to the desired setting.
- ▶ Open and set thermostatic radiator valves as required.
- ▶ Turn the boiler water temperature control to the required setting.
- ▶ To switch off the boiler; turn the programmer/timer to OFF for heating and hot water.

If the boiler is left unused and exposed to freezing conditions; shut off all the mains supplies, isolate the boiler and drain the system and boiler.

2.2.2 Setting the heating temperature

- ▶ Turn the control clockwise to increase the water temperature. The demand light will illuminate until the water reaches the set temperature. Once the set temperature is reached the demand light extinguishes
- ▶ Turn the control anti-clockwise to reduce the water temperature.

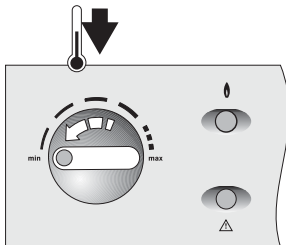
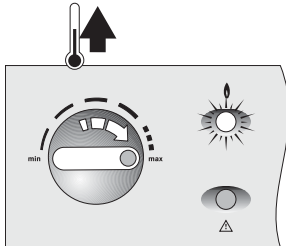

6720809404-02.1Wo

The minimum and maximum ranges of the temperature control positions are approximately 55°C to 81°C.

2.2.3 Controlling the central heating

- ▶ Set the programmer/timer to the correct time with the required ON/OFF periods.
- ▶ Turn the room thermostat to the temperature required.
- ▶ Set thermostatic radiator valves to the required temperature for each room.

2.2.4 Frost protection

- ▶ Frost thermostats can be wired into the boiler.
- ▶ Frost protection should be fitted to the system where the system is most exposed and at risk of freezing.



If there is no hot water or heating, check page 6 and 7 for fault condition guidance.

2.2.5 Fault conditions

The 'Demand' and 'Lockout' lights can indicate some basic fault conditions:

Normal operation

1. Demand light:

- ▶ Light ON - Demand for heat from the heating/hot water system.
- ▶ Light OFF - Boiler not firing, no demand from heating/hot water system.

Demand and Lockout lights

2. Both lights ON, boiler not firing:

- ▶ Check oil level in the oil storage tank.
- ▶ Press button (1). Boiler should fire.
- ▶ If no response, wait 2 minutes - press reset button (1) again.
- ▶ If lockout light stays on, do not attempt further resets. Contact your service engineer for advice.

3. Both lights OFF, boiler not ON, no heating/hot water

- ▶ Ensure there is a power supply to the boiler.
- ▶ Check the programmer is set to ON for heating.
- ▶ Check the setting of the room thermostat, boiler temperature control/tank thermostat.
- ▶ Press reset buttons (2 and 3).
- ▶ If the demand light stays off contact your service engineer for advice.

1)

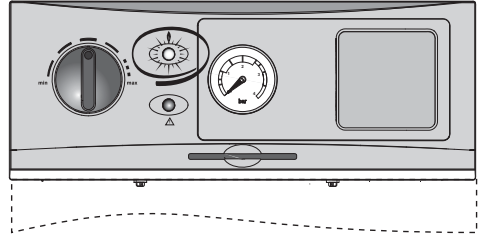

2)

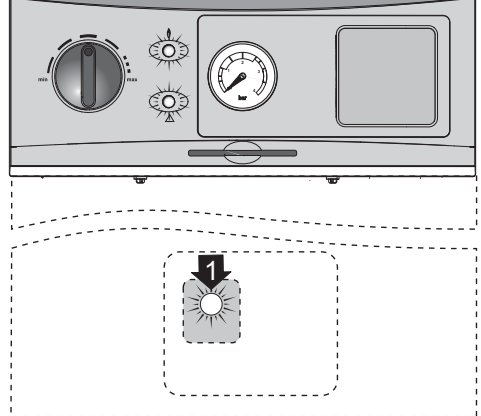

3)

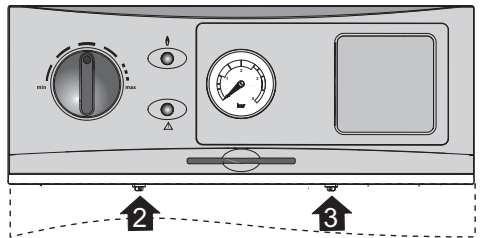

ACCESSING RESET BUTTONS:

PULL BOTTOM FRONT PANEL OUT AND LIFT TO REMOVE

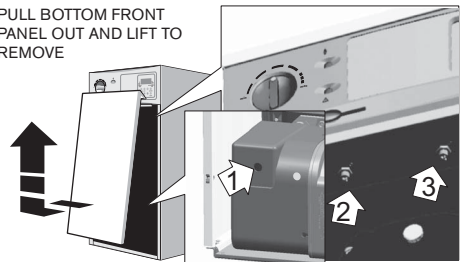

6720809404-03.1Wo

2.2.6 Fault finding

Problem	Cause	Remedy
Desired room temperature is not reached	Thermostatic radiator valve(s) set too low	Increase thermostatic radiator valve setting(s)
	Room temperature set too low	Increase room temperature setting
	Temperature control on the boiler set too low	Increase temperature control setting
	Air is trapped in the heating system	Bleed radiators and recharge heating system
Desired room temperature exceeded by large amount	Radiators are too hot	Turn down thermostatic radiator valves/room thermostat/boiler temperature control setting
Temperature rises instead of falling	Clock/programmer is incorrectly set	Check the setting
No Programmer display or Programmer does not respond	Momentary power failure	Switch off the boiler at the master switch, wait a few seconds and then switch the boiler on again
Hot water temperature too low	Hot water temperature set too low	Check the setting of the cylinder thermostat, then the boiler temperature control setting
	Cylinder is cold	Check programmer timings

3 Maintenance

3.1 Maintaining your boiler

Your new boiler represents a long term investment in a reliable, high quality product.

In order to realise its maximum working life and to ensure it continues to operate at peak efficiency and performance, it is essential that servicing and maintenance checks are performed at least once a year by an OFTEC engineer or other suitably qualified person.

If you would like to know more about servicing options from Worcester, Bosch Group, please visit worcester-bosch.co.uk. Please tick the appropriate box on your warranty registration card for further details of the Worcester, Bosch Group Service Contract.

When your boiler requires servicing please contact a Worcester, Bosch Group contact centre (see the back cover for details).

In addition to the service contract we are pleased to offer a one-off annual service or breakdown call out for your boiler.

Maintenance tips:

- Regularly check the oil level in the tank
- Do not obstruct the flue outlet or the air inlet
- Regularly check the system pressure gauge, see chapter 4

Use in hard water areas

In exceptionally hard water areas a device to prevent scale formation may be fitted. Installation of a scale inhibitor assembly should be in accordance with the requirements of the local water company.

An isolating valve should be fitted to allow for servicing.

3.2 Servicing

You must have the boiler regularly serviced by a competent, qualified OFTEC registered engineer using approved spares, to help maintain the economy, safety and reliability of the boiler.

The boiler should be serviced once each year after installation unless the installation conditions and usage demand more frequent services.



Ensure that the service engineer completes the Service Record in the checklist after each service.

The completed checklist will be required in the event of any warranty work and may be required by the local Building Control Inspector.

The checklist and service interval record can be found at the rear of the Installation, Commissioning and Servicing Instructions.

4 External filling loop (Sealed system only)



NOTICE: External filling loop

► If the filling loop does not look like the one shown in the figure below or you cannot find your filling loop, contact your installer.

Once the external filling loop has been located, follow the instructions for re-pressurising the system.

1. Ensure that the valve is turned off and unscrew the blanking cap.
2. Attach the hose to the valves, screw on hand-tight.
3. Turn the handle/screwdriver slot through 90° to open the valve.
4. The handle/screwdriver slot will be in-line with the valves.

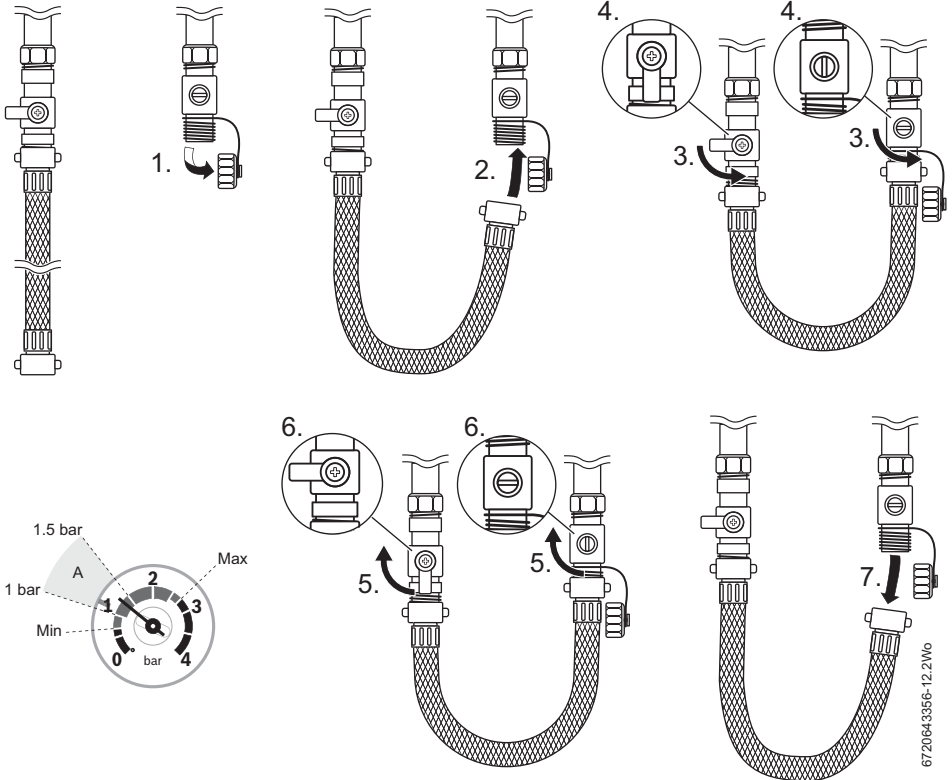

5. When the pressure reaches between the 1 and 1.5 bar marks (zone A), turn the handle/screwdriver slot back, through 90°, to close the valve.
6. The handle/screwdriver slot will be at 90° to the valves
7. Remove the hose and replace the blanking caps (a small amount of water will be present in the pipe).



If the pressure gauge reads more than 1.5 bar as a result of over filling, bleed one radiator until the pressure gauge returns to between 1 and 1.5 bar.

5 General information

5.1 Ventilation information

Boiler location

** The boiler can be installed under a worktop as long as:

- ▶ The worktop above the boiler is easily removable for maintenance.
- ▶ There is at least 10mm clearance above the boiler.
- ▶ The front of the boiler is not enclosed.

Ventilation

Air vents must be functional at all times and the air supply must not be restricted or contaminated.

The boiler clearances must meet the minimum shown below for servicing and venting purposes.

* If this clearance is less than 75mm the flue 'knock-out' panel sections must be removed to improve air circulation and cooling.

Do not place clothes or objects to hinder the air circulation required by the boiler.

5.2 Maintenance clearances

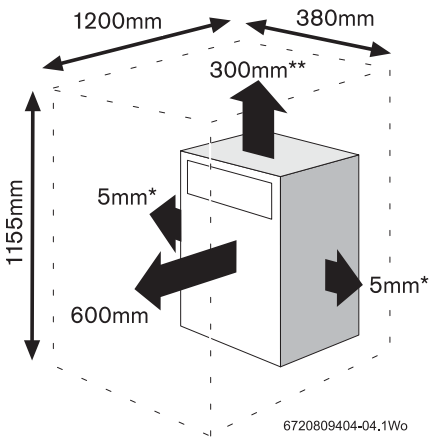

Conventional flue boilers require an adequate supply of fresh air which must be delivered to the boiler for combustion purposes through a permanent inlet, such as an air brick, into the area where the boiler is situated.

If a cupboard or compartment which is to be used for storage or airing is built around the boiler after installation there must be a non-combustible partition around the boiler. Refer to the installation manual for minimum vent sizes.

5.3 General notes

To get the best from your boiler, read these instructions carefully.

Central heating system

During the first few hours of operation of the central heating system, check that all radiators are being heated at an even rate. If the top of a radiator is at a lower temperature than the bottom then it should be vented by releasing air through the venting screw at the top of the radiator. Ask your installer to show you how this is done. Repeated venting will reduce the quantity of water in the system and this must be replenished for safe and satisfactory operation of the boiler.

When excessive venting or water leaks are found in the system you must contact a service engineer to inspect the installation and rectify any fault.

Only use additives compatible with the boiler and system. Use of incompatible additives can cause damage and will invalidate the boiler guarantee.

Condensate drain

This is a condensing boiler and the terminal will, at times give out a plume of water vapour. This is quite normal.

The boiler also produces quantities of condensate which is discharged regularly via a pipe to drain.

This pipe must not be blocked or altered in any way.

Clearances, see section 5.2

Your installer will have provided adequate space around the boiler for safety and servicing access.

Do not restrict this space with the addition of cupboards, shelves etc. next to the boiler.

Room thermostat

A room temperature controller must be fitted to control the central heating. Refer to instructions supplied with the thermostat for information on siting and setting.

Thermostatic radiator valves

It is recommended that this type of valve is fitted to all but one of the radiators (or at least those in the sleeping accommodation). The remaining radiator, which must be where the room thermostat is located, should be un-controlled and must be left open.

6 Energy saving

6.1 Tips on energy saving

Room thermostats

Reducing the setting of the room thermostat by 1°C can reduce fuel consumption by up to 10%.

New control systems

Upgrade your heating control system with the latest equipment available. The minimum level of control for a heating system is a programmer, interlocking room thermostat and thermostatic radiator valves.

Radiators

More often than not radiators will be sited underneath a window, so the warm air from the radiator heats the colder incoming air from the window.

The performance of the radiator will be affected if the curtains are allowed to drape over the radiator or shelves are fitted above it.

The positioning of furniture and tables in front of the radiator should also be avoided.

It is advisable to manually adjust all radiator valves every 2-3 months to prevent them from sticking. It is also important that the plastic tops of all valves are always in position and not cracked or damaged to help prevent accidents. Care should be taken when vacuum cleaning carpets to avoid damage to valves and pipework.

The heating system and the outputs of the radiators have been carefully selected by your installer. The temperature obtainable in any given room is dependent on all radiators being operated at the same time. If you decide to turn off radiators in unused rooms, spare bedrooms etc., you may experience slightly lower room temperatures in rooms adjacent to unheated rooms.

Heating economically

The boiler is designed to provide a high level of comfort while keeping oil consumption and the resulting environmental effect as low as possible.

The central heating control on the boiler should be set as low as possible while still maintaining a comfortable room temperature.

The temperature of each room can be set individually using the thermostatic radiator valves (except the primary room with the room thermostat).

Roof insulation

Around 30% of the heat loss from a property is through the roof. Replace any old insulation with new insulation, preferably to a minimum thickness of 200mm.

Window frames

Single glazed windows, particularly those with steel frames, can lose a great deal of heat.

Consideration should be given to replacement with uPVC or wooden framed double glazed units.

Curtains

Lined curtains, or heavier full length curtains can provide excellent insulation. However, always ensure that the curtains do not drape over radiators.

Draughts

Try to ensure that draughts around doors, windows, letterboxes and keyholes etc., are reduced by using a suitable draught excluder.

7 Guarantee

7.1 Fault or breakdown

This boiler is supported in mainland UK by Worcester, Bosch Group, part of Bosch Thermotechnology Ltd.

Specialist trained, Worcester, Bosch Group Service Engineers are available to attend in the unlikely event that a breakdown occurs on this boiler.

No charge will be made for parts and/or labour providing:

- ▶ A boiler fault is found and the boiler has been installed within the guarantee period.
Reasonable evidence of this must be supplied on request

If the boiler fails to give complete satisfaction, please check the following points before calling for a service engineer:

1. Oil level in the tank
2. Power to the boiler
3. All control settings

A call-out charge will be made where:

- ▶ The boiler has been installed for longer than the guarantee period. OR
- ▶ Our Field Service Engineer finds no fault with the boiler (see Note). OR
- ▶ Evidence cannot be provided that the first year service inspection has been carried out.
(i.e. an entry in the service interval record found at the rear of the boiler installation and servicing manual). OR
- ▶ The cause of breakdown is misuse or with other parts of your plumbing/heating system, or with equipment not supplied by Bosch Thermotechnology Ltd.



NO BOILER FAULT IS FOUND ON
OVER 30% OF ALL SERVICE CALL OUTS.

Please read this guide carefully to gain a good understanding of the operation of your boiler. In the case of a suspected fault, refer to the fault finding section of this guide.

If in doubt contact our Technical Support

In the event of an boiler fault or breakdown please contact our Service Department. Your service administrator will arrange for an Engineer to call with the minimum of delay. Under normal circumstances this will be from 1 to 3 working days (excluding weekends) for priority breakdown situations (no hot water and/or heating).

Invoices for attendance and repair work carried out on this boiler by any third party will not be accepted.

Boiler data label

The data label can be found on the condensate trap bracket on the right hand side.

To access first remove the front panel:

- ▶ Pull bottom of front panel to release lugs.
- ▶ Lift panel off top ledge (beneath the fascia) and remove from appliance.

To replace front panel:

- ▶ Hang the front panel on the top ledge.
- ▶ Gently push the panel at the base (from the edges so as not to damage the panel) until the panel clips into place.

(You can record this information on the inside back cover of this manual.)

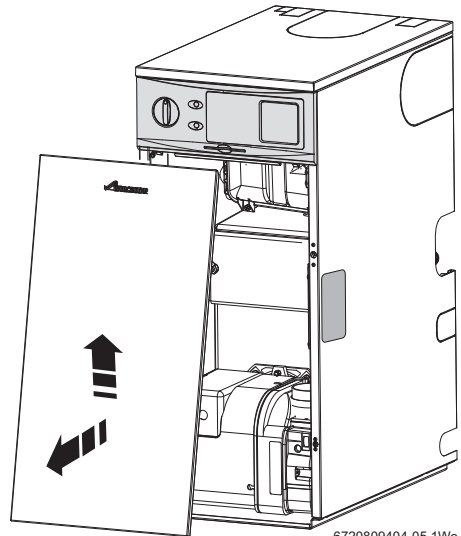

6720809404-05.1Wo

7.2 Guarantee registration

You should register the boiler within 30 days of installation.

Registering will acknowledge you as the owner of your new boiler and will assist us in maintaining an effective and efficient customer service by establishing a reference and permanent record for your boiler.

This does not affect your statutory rights.

Your guarantee

This boiler is guaranteed against faulty materials or workmanship for a period of 24 calendar months (60 months for the primary heat exchanger) from the date of installation subject to the following conditions:

- ▶ That during the period of this guarantee any components of the unit which are proved to be faulty or defective in manufacture will be exchanged or repaired free of material charges and free of labour charges if repaired directly by Bosch Thermotechnology Ltd.

Please be aware that invoices for attendance and repair of this boiler by third parties will not be accepted for payment by Bosch Thermotechnology Ltd.

- ▶ That the householder may be asked to prove, when requested, the date of installation, that the boiler was correctly commissioned and, where appropriate, that the 12 month service inspection has been carried out to the satisfaction of Bosch Thermotechnology Ltd, when requested. The boiler must be registered within 30 days of installation.
- ▶ That any product or part thereof returned for servicing under the guarantee must be accompanied by a claim stating the Model, Serial Number and Date of Installation.
- ▶ That Bosch Thermotechnology Ltd will not accept responsibility for damage caused by faulty installation, neglect, misuse or accidental damage and non-observance of the instructions contained in the Installation and Users Instructions leaflets.
- ▶ That the boiler has been used only for normal domestic purposes, for which it was designed.
- ▶ This guarantee applies only to equipment purchased and installed in mainland UK.

This guarantee is given in addition to all your normal statutory rights.

Worcester, Bosch Group is a brand name of Bosch Thermotechnology Ltd.

For you records:

Model	
Serial number*	
Type/size	
Date of installation	
Installer details	

[*] Refer to the boiler data label inside the casing

Notes

Notes

If in the unlikely event the boiler does not give complete satisfaction, before calling for a service engineer, the installer should check the following:

General checks:

1. Oil level in the tank
2. Power to the boiler
3. All control settings



NOTICE: NO BOILER FAULT IS FOUND ON
OVER 30% OF ALL SERVICE CALL OUTS.

Please read the fault section of the manual before contacting our service team.

WORCESTER, BOSCH GROUP:

TECHNICAL SUPPORT:	0330 123 3366
APPOINTMENTS:	0330 123 9339
SPARES:	0330 123 9779
LITERATURE:	0330 123 9119
TRAINING:	0330 123 0166
SALES:	0330 123 9669

Worcester, Bosch Group
Cotswold Way, Warndon, Worcester WR4 9SW.
Tel. 0330 123 9559
Worcester, Bosch Group is a brand name of
Bosch Thermotechnology Ltd.

worcester-bosch.co.uk

6 720 809 404 (2013/10)



WORCESTER
Bosch Group