

USER INSTRUCTIONS

WALL HUNG RSF GAS FIRED CONDENSING COMBINATION BOILER

Greenstar CDi Compact

FOR SEALED CENTRAL HEATING SYSTEMS AND MAINS FED DOMESTIC HOT WATER



The appliances are for use with:
Natural Gas or L.P.G. (Cat. II 2H 3P type C13, C33 & C53)

Natural Gas: 28CDi Compact GC number 47-406-44
32CDi Compact GC number 47-406-46
36CDi Compact GC number 47-406-48

L.P.G.: 28CDi Compact GC number 47-406-45
32CDi Compact GC number 47-406-47
36CDi Compact GC number 47-406-49



WORCESTER
Bosch Group

PREFACE

PLEASE READ THESE INSTRUCTIONS CAREFULLY

These instructions are applicable to the Worcester, Bosch Group boiler model stated on the front cover only.

These instructions apply in the UK/IE only and must be followed except for any statutory obligation.

After installation, please leave this User Instruction manual and the Installation, Commissioning and Servicing Instructions with the user.

DEDICATED TO HEATING COMFORT

Thank you for purchasing a Greenstar gas-fired condensing combination boiler manufactured by Worcester, Bosch Group. The company prides itself on manufacturing boilers to the strictest quality control standards throughout every stage of production. Worcester, Bosch Group has led the field in innovative boiler design and performance for over 50 years. This heritage means all our products are of exceptional quality and proven reliability.

The Greenstar range in particular is extremely energy efficient, offering you economical running costs and value for money. With a SEDBUK 2009 efficiency rating of 89.8%, the Greenstar CDi Compact series are amongst the top energy rated boilers available. There is also the reassurance of our no-nonsense 2 years parts and labour guarantee, backed up by Worcester Total Cover, an optional complete maintenance scheme to keep your boiler operating at peak condition and efficiency.

CONTENTS

1	Symbols and safety precautions	3
1.1	Explanation of symbols	3
1.2	Safety precautions	3

2	General Information	4
----------	----------------------------------	----------

3	Controls	5
3.1	Operating the boiler	7
3.1.1	Boiler display	7
3.1.2	Setting the boiler flow temperature for the central heating system	7
3.1.3	Boiler frost protection	7
3.1.4	Turning the central heating off during the summer	8
3.1.5	Setting the flow temperature for domestic hot water system	8
3.1.6	Domestic hot water preheat (without fascia timer fitted)	8
3.1.7	Domestic hot water preheat (with fascia timer fitted)	9
3.1.8	Domestic hot water eco mode	9
3.1.9	Boiler alert state	10
3.1.10	Boiler reset	10
3.1.11	Turn off the Operation/fault diagnostic light (blue)	10

4	System Pressure	11
4.1	Sealed heating systems	11
4.2	Using the Worcester integral filling link	12

5	Service Clearances	13
----------	---------------------------------	-----------

6	Maintaining your Boiler	13
----------	--------------------------------------	-----------

7	Fault Finding	14
7.1	Extreme cold weather	15

8	Fault or Breakdown	16
----------	---------------------------------	-----------

9	Tips on energy saving	16
----------	------------------------------------	-----------

10	Environment / disposal	17
-----------	-------------------------------------	-----------

11	Your guarantee	18
-----------	-----------------------------	-----------

12	Glossary	19
-----------	-----------------------	-----------

1 SYMBOLS AND SAFETY PRECAUTIONS

1.1 EXPLANATION OF SYMBOLS

WARNING SYMBOLS

	Safety instructions in this document are framed and identified by a warning triangle which is printed on a grey background.
--	---

Signal words indicate the seriousness of the hazard in terms of the consequences of not following the safety instructions.

- **NOTICE** indicates possible damage to property or equipment, but where there is no risk of personal injury.
- **CAUTION** indicates possible personal injury.
- **WARNING** indicates possible severe personal injury.

IMPORTANT INFORMATION

	Notes contain important information in cases where there is no risk of personal injury or material losses and are identified by the symbol shown on the left. They are bordered by horizontal lines above and below the text.
--	---

ADDITIONAL SYMBOLS

Symbol	Meaning
1.	a numbered step in an action sequence
▶	a step in an action sequence
	a reference number to identify or refer to a part or item
•	a list entry
–	a list entry (second level)

1.2 SAFETY PRECAUTIONS

IF YOU SMELL GAS

A gas leak could potentially cause an explosion. If you smell gas, observe the following rules.

- ▶ Prevent flames or sparks:
 - Do not smoke, use a lighter or strike matches.
 - Do not operate any electrical switches or unplug any equipment.
 - Do not use the telephone or ring doorbells.
- ▶ Turn off the gas at the meter.
- ▶ Open windows and doors.
- ▶ Warn your neighbours and leave the building.
- ▶ Prevent anyone from entering the building.
- ▶ Well away from the building: call the National Gas Emergency Service on 0800 111 999.

BOILER OPERATION:

This boiler must only be operated by a responsible adult who has been instructed in, understands and is aware of the boiler's operating conditions and effects.

COMBUSTIBLE AND CORROSIVE MATERIALS:

Chemically aggressive substances can corrode the boiler and invalidate any guarantee.

- Do not store or use any combustible materials (paper, thinners, paints, propellants, cleaning agents etc.) inside the cupboard containing the boiler or within the vicinity of the appliance.

FITTINGS AND MODIFICATIONS:

Only a competent engineer can remove the boiler case and carry out any work, in accordance with the Gas Safety (Installation and Use) Regulations.

- Do not remove the boiler case.

Any misuse or unauthorised modifications to the boiler, flue or associated accessories and heating system will invalidate the guarantee.

- Do not modify the boiler or flue system in any way.

Worcester, Bosch Group accepts no liability arising from any such actions. This does not affect your statutory rights.

CLEANING THE BOILER CASE:

Use a damp, soft cloth to clean the outer metal case of the boiler, do not use chemicals or abrasive materials.

2 GENERAL INFORMATION

SERVICING



Ensure that the service engineer completes the Service Record in the Benchmark Checklist after each service. The Benchmark Checklist and service interval record can be found at the rear of the Installation, Commissioning and Servicing Instructions.

- The boiler must be serviced regularly by a competent, qualified person, such as a Worcester service engineer or other Gas Safe registered engineer.
- Always use original spares, to help maintain the efficiency, safety and reliability of the boiler and have the Service Record completed in the Benchmark Checklist.

The completed Benchmark Checklist will be required in the event of any guarantee work and may be required by the local Building Control Inspector.

BENCHMARK STANDARD



The Benchmark initiative is a code of practice to encourage the correct installation, commissioning and servicing of domestic central heating boilers and system equipment.

A "checklist" is dispatched with every boiler and can be found towards the back of the Installation, Commissioning and Servicing Instructions. This is a vital document that needs to be completed by the installer at the time of installation. It confirms that the boiler has been installed and commissioned

according to the manufacturer's instructions.

The log book provides space for the recording of regular servicing of the boiler/heating system and this can become a valuable document when, for example, you wish to sell the property. The log book will show a potential purchaser that the heating system has received regular professional maintenance and servicing during its lifetime.

The Benchmark initiative aims to:

- Raise standards among professional installers
- Build and maintain high safety standards in the industry
- Improve customer satisfaction levels
- Make a contribution to the nation's commitment to climate change

3 CONTROLS

► To gain access to the boiler controls pull the flap down using the curved flap handle.

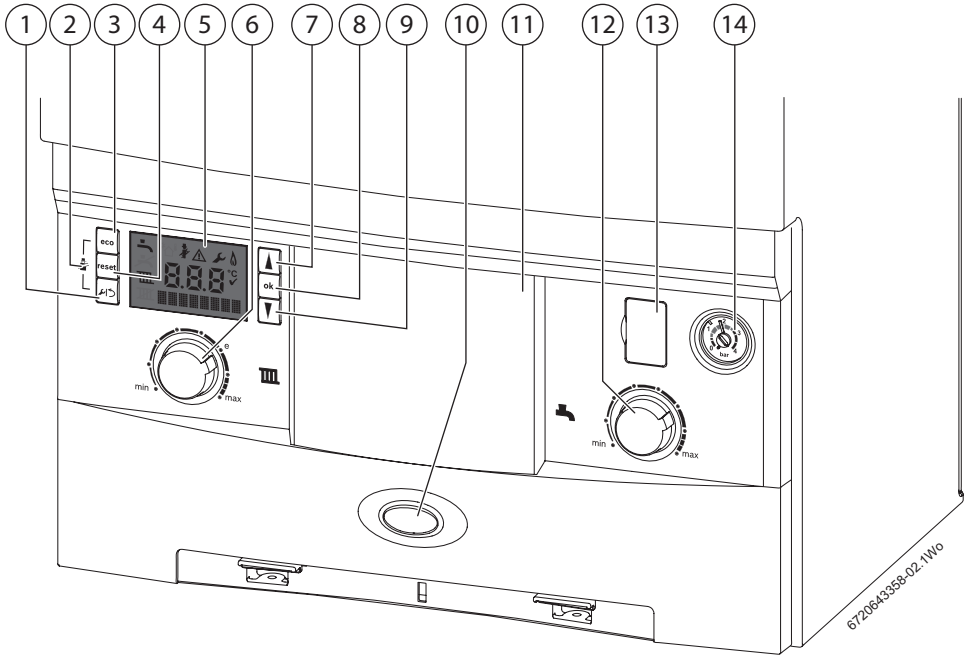

Fig. 1 Basic boiler controls

Boiler Controls	1	Service menu/back button	9	Scroll down button
	2	Service engineer symbol = boiler is set to maximum or minimum output for service	10	The blue light is ON when the boiler is in an operational mode. It will also flash to indicate a fault.
	3	Eco button	11	Position for optional programmer
	4	Reset button	12	Hot water temperature control
	5	Boiler display	13	Diagnostic port*
	6	Central heating temperature control	14	Central heating system pressure gauge
	7	Scroll up button		
	8	OK - Select/confirmation button		

* for Worcester service engineer use only

DISPLAY SYMBOLS

SCREEN DISPLAY	BRIEF DESCRIPTION	EXPLANATION
	All possible screen symbols	This screen is displayed briefly during boiler start up and shows all the symbols that could be displayed on the screen.
	Numerical display	Displays a temperature setting or boiler status code.
	Text display	Display PreHeat or Eco, or the Alert code
	Hot water	Displays this symbol during a DHW demand.
	Central Heating	Displays this symbol during central heating demand.
	Service engineer mode	Displays during service when the boiler is set to maximum or minimum output.
	Alert	Displays along with the boiler status code and diagnostic code during a fault condition.
	Service mode	Displays when a qualified service engineer is in the service menus.
	Burner on	The boiler is in operation and the flame is alight.
	Centigrade indication	Displays next to the temperature reading.
	Confirmation	This symbol confirms a manual change.

3.1 OPERATING THE BOILER

3.1.1 BOILER DISPLAY

This is typical of the display when the boiler is not supplying a central heating or hot water demand.

The display will not be backlit and the internal temperature of the boiler is displayed.

When heat is demanded and the boiler fires up, the flame symbol will be displayed.

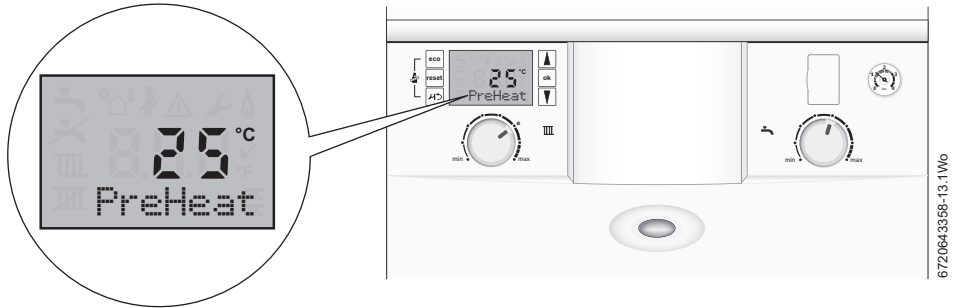

3.1.2 SETTING THE BOILER FLOW TEMPERATURE FOR THE CENTRAL HEATING SYSTEM

1. Turn the central heating temperature control knob to the desired flow temperature between 30 and 82°C, this will be indicated on the digital display. This is not the room temperature but the flow temperature through the radiators. The "e" point provides guidance for the maximum temperature setting for optimum energy efficiency.
2. The radiator symbol will be displayed to confirm that the a central heating setting is being changed.
3. The value is displayed during this process, press to exit or after five seconds of inactivity the boiler display will return to the default screen.

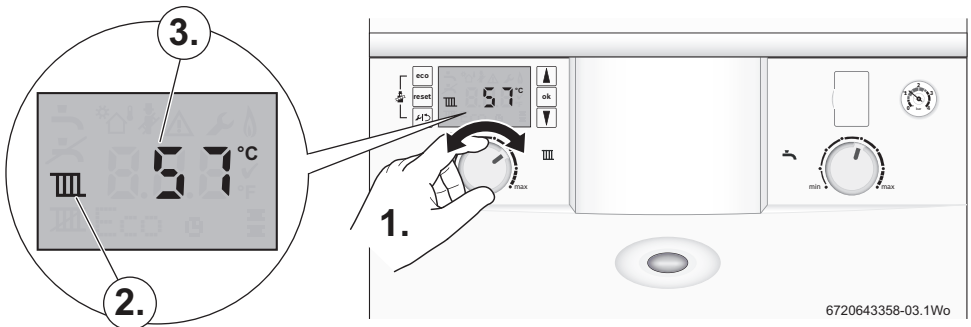

► Comfort levels within rooms should be controlled by your thermostatic radiator valves and/or room thermostat.

3.1.3 BOILER FROST PROTECTION

If you are leaving your property unoccupied during cold weather, please leave your programmer on constant and your room thermostat set to 15°C.

- If the temperature within the boiler falls below 8°C the pump will run to circulate water and prevent the system freezing.
 - If the temperature does not rise to 9°C within 30 minutes of the pump operating, the boiler will fire up to provide heat to bring the temperature up.
- If the temperature within the boiler falls below 5°C the boiler will fire immediately, bringing the boiler temperature up to 12°C to avoid the possibility of the system freezing.
- This process will be repeated until such time that the boiler temperature does not drop below 5°C.

3.1.4 TURNING THE CENTRAL HEATING OFF DURING THE SUMMER

- ▶ Turn your programmer/timer to the off position.
- ▶ Please refer to the programmer/timer manufacturer's instructions.

3.1.5 SETTING THE FLOW TEMPERATURE FOR DOMESTIC HOT WATER SYSTEM

1. Turn the hot water temperature control knob to the desired level between 40 and 60°C, this will be shown on the digital display.

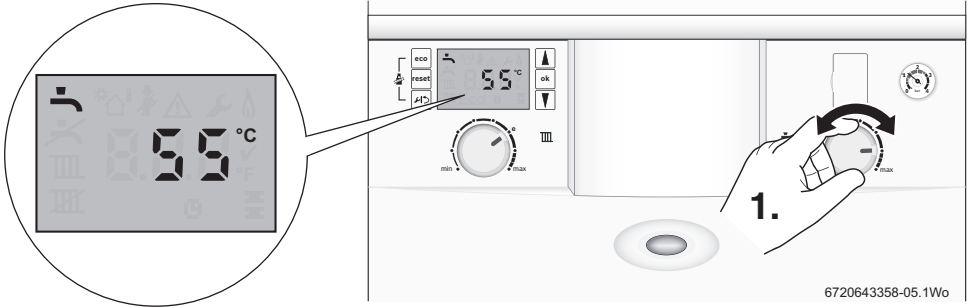

The value is displayed during this process, press **ok** to exit or after five seconds of inactivity the boiler display will return to the default screen.

3.1.6 DOMESTIC HOT WATER PREHEAT (without fascia timer fitted)

The hot water heat exchanger is kept pre-heated to reduce the time taken to deliver hot water at the tap. Pre-heat is enabled by default, during the initial boiler start up and PreHeat is displayed.

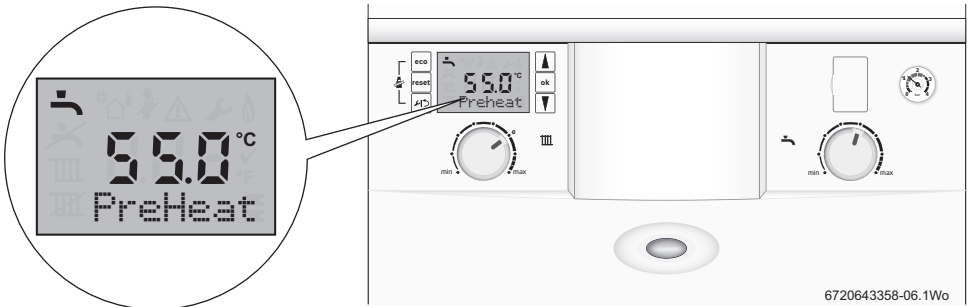

In the PreHeat mode, if there has been no demand for hot water for 24 hours the boiler will save energy by suspending PreHeat until there is a demand for hot water. At this time PreHeat mode is re-activated.

3.1.7 DOMESTIC HOT WATER PREHEAT (with fascia timer fitted)

When a Worcester twin channel programmer is fitted, the PreHeat/Eco option can be selected via the programmer.

Eco mode timed by a programmer will be displayed as shown below (1). Refer to the programmer manual for details on how to set the time periods.

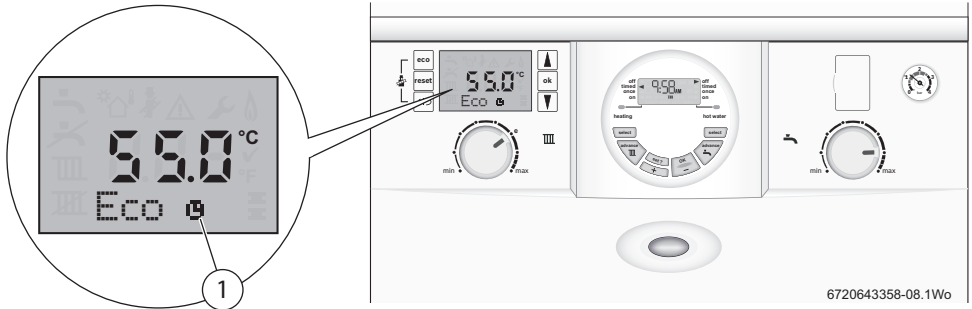

3.1.8 DOMESTIC HOT WATER ECO MODE

Eco mode is an energy saving feature which disables the Pre-heat function:

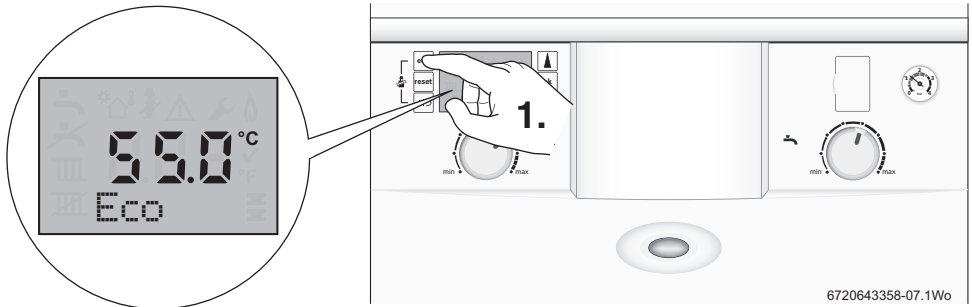

By selecting Eco mode you will be using less energy, but will have to wait a little longer for hot water.

1. Press and hold  for at least four seconds to enter the energy saving Eco mode, when Eco mode is active, "Eco" will be displayed.



- To exit ECO mode and return to PreHeat, press and hold  for at least four seconds, PreHeat will be displayed.

3.1.9 BOILER ALERT STATE

In the event of an alert, a fault code and an alert symbol  will be displayed on the boiler display, and the blue operation/fault light will flash. Refer to the Fault finding section on page 14 or press  to clear the problem.

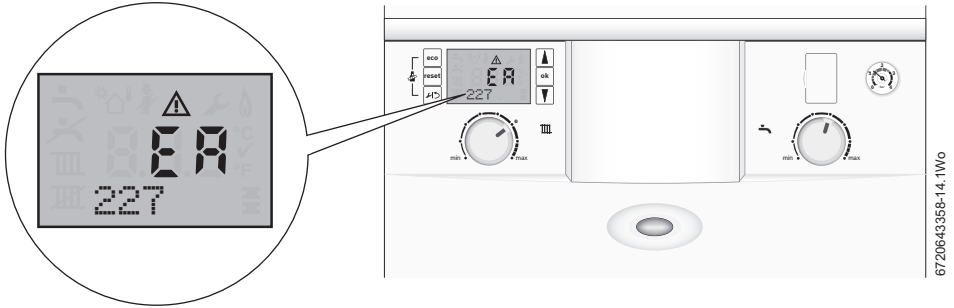

3.1.10 BOILER RESET

1. To reset the boiler, press .

2. "Reset" and  are briefly displayed.

- ▶ If the reset was successful the boiler will return to normal operation.
- ▶ If the reset was not successful then the alert code will be displayed again, and the blue operation/fault light will continue to flash.

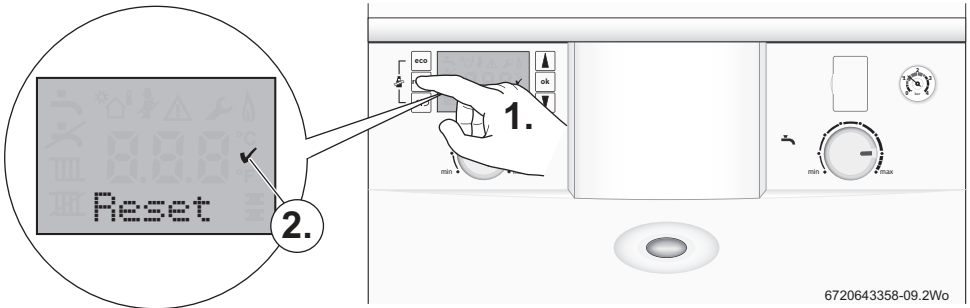

If the fault remains and cannot be cleared by pressing the reset button, contact Worcester, Bosch Group for assistance on 0844 892 3000.

3.1.11 TURN OFF THE OPERATION/FAULT DIAGNOSTIC LIGHT (BLUE)

Your new Greenstar CDi Compact boiler is designed to use as little electricity as possible during operation and in stand-by mode. To further enhance your energy saving during stand-by, you may choose to deactivate the operation/fault diagnostic light. The light will still flash to alert you to a possible fault, but will not activate during a demand for heat. Please ask your installer to activate this feature.

4 SYSTEM PRESSURE

4.1 SEALED HEATING SYSTEMS

This boiler is fitted to a sealed heating system which is pre-pressurised.

Your installer will advise you of the minimum and maximum pressure indicated on the pressure gauge.

- ▶ Check regularly that the pressure is maintained.

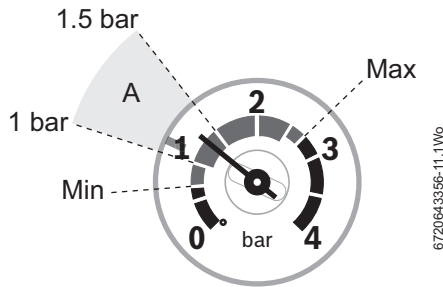

Fig. 2 Optimum system pressure when your boiler is cold (area A)

- ▶ Contact your installer or maintenance engineer if a permanent significant decrease or increase in pressure is indicated on the pressure gauge.
- ▶ Use the Worcester integral filling link to re-pressurise your boiler, refer to the following section 4.2.



NOTICE: To comply with the Water Authority regulations you must remove the “filling key” or disconnect the external filling loop after re-pressurisation.

4.2 USING THE WORCESTER INTEGRAL FILLING LINK

Locate filling key and follow instructions for re-pressurising.

1. Push the filling key firmly into the body of the filling link, ensuring the arrow on the key shaft lines up with the open padlock symbol.
2. Turn the filling key to the right, to the stop, so the arrow now lines up with the closed padlock symbol. This bridges the gap between the two sections of the filling loop.
3. Turn the white knob to the left, this will allow water to fill the system.

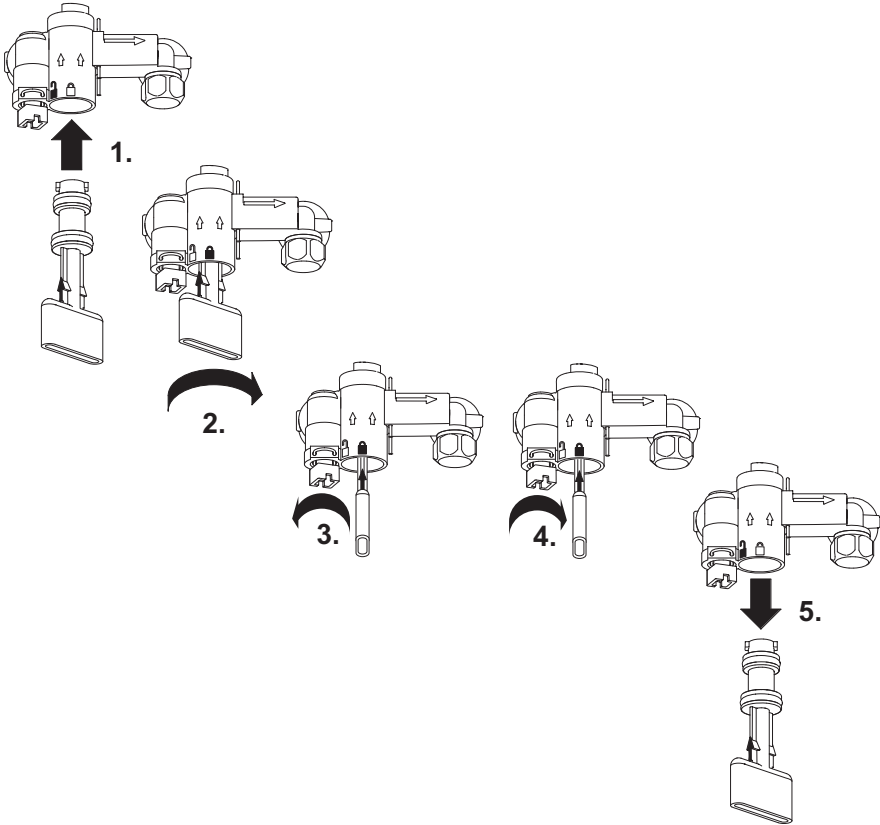

6720643356-10.2Wo

Fig. 3 Inserting the filling key

4. When the pressure, shown on the boiler fascia pressure gauge, reaches between the 1 and 1.5 bar marks, turn the white knob to the right to close the valve. Do not overtighten.
5. Turn the filling key to the left, to the stop, so that the arrow lines up with the open padlock symbol and pull the key straight down to remove. Please remember to store the key in the bottom panel.



If the pressure gauge reads more than 1.5 bar as a result of over filling, please bleed one radiator until the pressure gauge returns to between 1 and 1.5 bar.

5 SERVICE CLEARANCES

Your installer will have provided adequate space around the boiler for safety and servicing access.



CAUTION: Restricted space.

The boiler may overheat.

▶ Do not restrict this space with the addition of cupboards, shelves etc. next to the boiler.

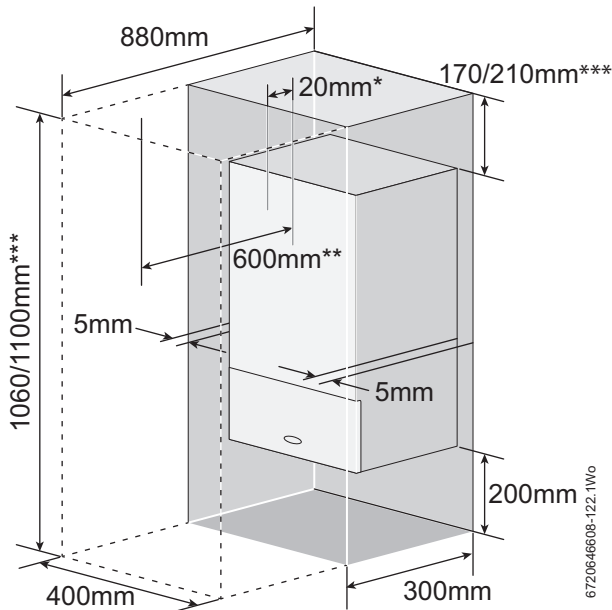

Fig. 4 Service clearances

*	Minimum clearances to removable door
**	Minimum clearance required for servicing
***	Height for either 60/100 flue or 80/125 flue

6 MAINTAINING YOUR BOILER

Your new Greenstar gas-fired combi boiler represents a long term investment in a reliable, high quality product.

Wipe the boiler casing with a soft clean cloth. Please do not use chemical cleaning products which may damage the paint finish. In order to realise its maximum working life, and to ensure it continues to operate at peak efficiency and performance, it is essential that your boiler receives regular servicing and maintenance checks from a competent person beyond the initial two year guarantee period.

If your Greenstar gas-fired boiler should fail to operate correctly or requires servicing, please contact the Worcester, Bosch Group Appointments Team (see rear cover for details).

Details of the boiler including the Gas Council number can be found on the front cover of these User Instructions and on the boiler identification label on the boiler fascia.

The Gas Council number is also listed on the front cover of your Installation, Commissioning and Servicing Instructions.

7 FAULT FINDING

In the event that the boiler stops functioning or does not perform as expected, you can carry out a few simple checks. These checks are some of the most common causes and are listed in the table below. Should the problem persist or if other alert codes are displayed, then it will be necessary to contact the Worcester, Bosch Group.

Problem	Cause	Remedy
EA fault code flashing on display	No gas supply/low gas supply pressure	▶ Contact your gas supplier.
	Condensate outlet blocked	▶ If it is safe to do so, check your condensate pipe outlet for blockages, such as ice or foreign objects.
	Flue blocked	▶ If it is safe to do so, check your flue outlet for damage or blockages.
Desired room temperature is not reached	Thermostatic radiator valve(s) set too low	▶ Increase thermostatic radiator valve setting(s).
	Temperature control for central heating flow on boiler set too low	▶ Increase central heating flow temperature control setting
	Air trapped in heating system	▶ Bleed radiators and re-pressurise the heating system
	Low system water pressure	▶ Re-pressurise the system, refer to page 12
	Low temperature setting on the boiler controls	▶ Increase settings on boiler controls
Desired room temperature too high	Radiators are too hot	<ul style="list-style-type: none"> ▶ Turn down thermostatic radiator valves/room thermostat ▶ Reduce central heating temperature by turning down the Central Heating control on boiler
Heating stays on for too long	Clock is incorrectly set	▶ Check clock setting and adjust
No blue Operation/Fault Indicator	Momentary power failure	▶ Disconnect boiler supply, wait a few seconds then reconnect.
	Energy saving feature is activated	▶ Ask your installer to reset the blue light
Hot water temperature too low	Temperature set too low on boiler controls	▶ Check setting and adjust
	Water flow at tap too high	▶ Reduce flow rate at tap
	Air trapped in heating system	▶ Bleed radiators and re-pressurise the heating system
	Low system water pressure	▶ Re-pressurise the system, refer to page 12
Hot water temperature too high	Temperature set too high on boiler controls	▶ Check setting and adjust
	Water flow at tap too low	▶ Increase flow rate at tap

Table 1 Fault finding

ALERT CODES

If the blue operation/fault indicator light on the front of your boiler is flashing and a warning triangle  is displayed with an alert code on the screen, e.g. EA, reset your boiler, refer to page 10.

Press , if the reset has been successful the word Reset will be displayed with the tick mark to confirm that the reset was successful.

After a few seconds of a successful reset the boiler display will return to a normal display, the display sequence is shown in figure 5 below.



6720643358-10.2Wo

Fig. 5 Resetting a fault condition

Due to the internal safety systems of your Greenstar CDi Compact boiler, some codes cannot be cleared by a simple reset. Please contact Worcester, Bosch Group for further assistance.

When calling Worcester, Bosch Group about a fault, it will be useful to quote the alert code and three digit number under the alert code, e.g. EA and 227. If there is a fault that cannot be reset by you, the user, then a service engineer visit will be necessary.

7.1 EXTREME COLD WEATHER

In some instances where the condensate pipe work is run externally or in an unheated area, such as a garage, the condensate pipe work can be at risk of freezing, even if well insulated.

A frozen/blocked condensate pipe will cause the boiler to shut down.



WARNING: Falling hazard!
Failure to follow this guidance may result in personal injury.

- ▶ Only attempt to thaw a condense pipe that is at ground level and easily accessible.
- ▶ Never attempt to thaw a condense pipe that is at height.



CAUTION: Pipe damage
▶ **DO NOT** use boiling water to thaw the condensate pipe!

If the condensate pipe has frozen:

- ▶ Locate the blockage.
It is likely that the pipe is frozen at the most exposed point outside the building or where there is an obstruction to flow. This could be the open end of the pipe, at a bend or elbow, or where there is a sag in the pipe in which condensate can collect. The location of the blockage should be identified as closely as possible before taking further action.
- ▶ Thaw the frozen pipe.
The pipe can be thawed by applying a hot water bottle, a microwaveable heating pack (the sort used for muscular aches and pains) or a cloth soaked in hot water to the exterior of the pipe, close to the point of blockage.
Hot water, but not boiling, can also be poured onto the pipe from a watering can or similar container. Care must be taken at pedestrian areas where this water may freeze and create a slip hazard.
- ▶ Once the pipe has been thawed the boiler must be reset, press the reset button for five seconds and wait two to three minutes for the boiler to restart.
- ▶ If the boiler does not restart, contact Worcester, Bosch Group Appointments Team on: 0844 892 3000.
- ▶ Contact your installer in order to find a permanent solution to the problem.

8 FAULT OR BREAKDOWN

This boiler is supported in the UK and Eire by Worcester, Bosch Group. Specialist service engineers are available to attend a breakdown occurring on this boiler.



Invoices for attendance and repair work carried out on this boiler by any third party will not be accepted.

- No charge will be made for parts and/or labour providing:
 - A boiler fault is found and the boiler is within the guarantee period. Reasonable evidence of this must be supplied on request. i.e. the Benchmark Checklist.
- A call-out charge will be made where:
 - The boiler is outside the guarantee period.
 - Evidence cannot be provided that the first year service inspection has been carried out (i.e. an entry in the Benchmark Checklist).
 - Our Field Service Engineer finds no fault with the boiler.
 - The cause of breakdown is misuse or with other parts of your plumbing/heating system, or with equipment not supplied by Worcester, Bosch Group.

TECHNICAL SUPPORT



No boiler fault is found on over 30% of all service calls.

In the case of a suspected fault, refer to the fault finding section of this guide.

In the event of a boiler fault or breakdown please contact Worcester, Bosch Group appointments team on 0844 892 3000. Your advisor will arrange for an engineer to call with the minimum of delay; under normal circumstances this will be from 1 - 3 working days (excluding weekends and bank holidays) for priority breakdown situations (no hot water and/or heating).

9 TIPS ON ENERGY SAVING

HEATING ECONOMICALLY

The boiler provides a high level of comfort whilst keeping gas consumption low and so minimising the environmental impact.

The gas supply to the boiler's burner is regulated according to the demand for heat. The boiler operates with a low flame if the demand for heat reduces. The technical term for this process is modulating control.

Modulating control reduces temperature fluctuations and provides an even distribution of heat throughout the home. This means that the boiler may stay on for relatively long periods of time but will use less gas than a boiler that continually switches on and off.

CENTRAL HEATING SYSTEMS WITH ROOM THERMOSTAT/THERMOSTATIC RADIATOR VALVES

With modern heating systems designed around a 20 °C heat loss across the system, the optimum setting for a condensing boiler will be approximately between one and two on the central heating temperature control. The system must be balanced correctly and the radiators may need upgrading.

The temperature of each room can be set individually (except primary room with the room thermostat) using the thermostatic radiator valves.

ROOM THERMOSTATS

Reducing the setting of the room thermostat by 1 °C can reduce fuel consumption by up to 10%.

NEW CONTROL SYSTEMS

Upgrade your heating control system if necessary with the latest equipment available.

ROOF INSULATION

Around 30% of the heat loss from a property is through the roof. Replace any old insulation with new insulation, preferably of around 200mm thickness or more.

WINDOW FRAMES

Single glazed windows, particularly those with steel frames, can lose a great deal of heat. Consideration should be given to replacement with PVCu or wooden framed double glazed units.

RADIATORS

If a radiator is sited underneath a window, its performance will be affected if the curtains are allowed to drape over the radiator. Shelves fitted above or in front of the radiator should also be avoided.

It is advisable to manually adjust all thermostatic radiator valves every 2 - 3 months to prevent them sticking. Ensure radiator valves are correctly set and not damaged.

DRAUGHTS

Try to ensure that draughts around doors, windows, letterboxes and keyholes etc. are reduced by using a suitable draught excluder.

**WARNING:** Air vents

- ▶ Do not block or seal any air vents that are installed to ensure that the central heating boiler operates safely.

CURTAINS

Lined curtains, or heavier full length curtains can provide excellent insulation. However, always ensure that the curtains do not drape over radiators.

10 ENVIRONMENT / DISPOSAL

Environmental protection is a fundamental corporate strategy of the Bosch Group.

The quality of our products, their economy and environmental safety are all of equal importance to us and all environmental protection legislation and regulations are strictly observed.

We use the best possible technology and materials for protecting the environment taking account of economic considerations.

PACKAGING

We participate in the recycling programmes of the countries in which our products are sold to ensure optimum recycling. All of our packaging materials are environmentally compatible and can be recycled.

**USED APPLIANCES**

- ▶ All Greenstar gas boilers are 100% recyclable.
The various assemblies can be easily dismantled and synthetic materials are marked accordingly. Assemblies can therefore be sorted by composition and passed on for recycling.

11 YOUR GUARANTEE

This boiler has a guarantee against faulty materials or workmanship for a period of two years from the date of installation subject to the following terms and conditions:

- During the period of this guarantee any components of the boiler which are proven to be faulty or defective in manufacture will be exchanged or repaired free of charge by Bosch Thermotechnology Ltd.
- The householder may be asked to prove the date of installation, that the boiler was correctly commissioned and, where appropriate, the first year's service has been carried out to the satisfaction of Bosch Thermotechnology Ltd., when requested. These should be documented as a part of the Benchmark Checklist.
- The boiler has been used only for the normal domestic purposes for which it was designed.

This guarantee does not affect your statutory rights.

GUARANTEE REGISTRATION

Your Greenstar boiler carries a two year guarantee against faulty material or manufacturer subject to Terms and Conditions.

To read the full Terms & Conditions please visit us on-line at www.worcester-bosch.co.uk/guarantee. The Guarantee Registration form is available on this same page and can be completed and submitted electronically.

Alternatively, please telephone one of our Guarantee Registration advisors on 0844 892 2552.

Your statutory rights are not affected by the manufacturers guarantee.

FOR YOUR OWN RECORD:

Please ensure that the Benchmark Checklist has been completed by your installer or service engineer.

Model	
Serial No. ¹⁾	
Type/size	
Date of installation	
Name of Installer	
Telephone number of Installer	

Table 2

- 1) See boiler identification label on boiler fascia or Benchmark Checklist in the back of the Installation, Commissioning & Servicing Instructions.

12 GLOSSARY

Central heating systems

All radiators must be heated at an even rate. If the top of a radiator is at a lower temperature than the bottom then it should be bled by releasing air through the bleed screw at the top of the radiator.

Ask your installer to show you how this is done.

This boiler is fitted to a sealed system. Should water leaks be found or if excessive bleeding is required, then a service engineer must be contacted to inspect the installation and rectify any fault.

Only additives that are compatible with aluminium may be used in the system. Any incompatible additive used will invalidate the guarantee.

Plumbing and condensate drain

This is a condensing boiler and the flue terminal will, at times give out a plume of water vapour. This is quite normal.

The boiler produces condensate which is discharged regularly by a syphon within the boiler via a plastic pipe to a drain. This pipe must not be blocked or altered in any way.

Room thermostat / programmer

A room thermostat / programmer must be fitted to control the central heating. This controls the times and temperatures of the central heating, preventing the boiler from firing unnecessarily. Refer to the instructions supplied with the thermostat and programmer for further information.

Thermostatic radiator valves

Thermostatic radiator valves must be fitted in sleeping accommodation. It is recommended that this type of valve is fitted to all but one of the radiators. The remaining radiator, where the room thermostat is located, must be uncontrolled and left open.

Pump over run function

After the boiler has finished a demand for central heating or hot water, the pump may continue to run for a short while to dissipate the heat from within the boiler.

Pump anti-seizure

If there has been no heating demand for 24 hours, the boiler will run the system pump for a few seconds to reduce the possibility of pump seizure during long periods of inactivity.

SEDBUK

Seasonal Efficiency of Domestic Boilers in the UK.

Worcester, Bosch Group
Cotswold Way, Warndon, Worcester WR4 9SW.
Tel. 0844 892 9900
Worcester, Bosch Group is a brand name of
Bosch Thermotechnology Ltd.

worcester-bosch.co.uk

6 720 803 801 (2012/09)

WORCESTER, BOSCH GROUP:

TECHNICAL SUPPORT: 0844 892 3366
APPOINTMENTS: 0844 892 3000
SPARES: 01905 752571
LITERATURE: 0844 892 9800
TRAINING: 01905 752526
SALES: 01905 752640



WORCESTER
Bosch Group