

OPERATING INSTRUCTIONS FOR THE USER

HYBRID SYSTEM WITH AIR TO WATER HEAT PUMP

GREENSTAR PLUS HYBRID

FOR COMBINATION WITH WORCESTER APPLIANCES THAT HAVE A CENTRAL HEATING OUTPUT UP TO 28kW

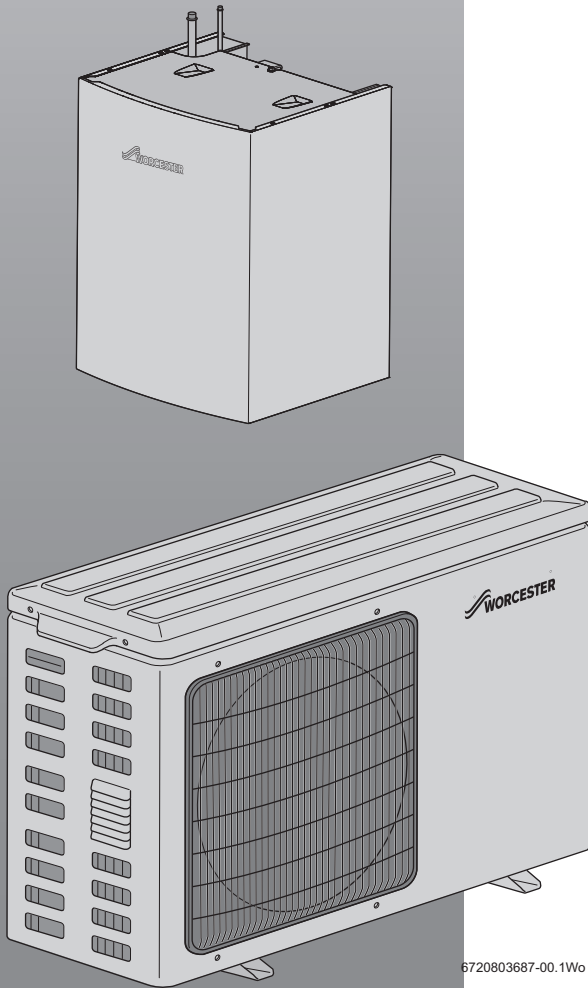

6720803687-00.1W6



PREFACE

PLEASE READ THESE INSTRUCTION CAREFULLY

These instructions are applicable to the Worcester, Bosch Group appliance model stated on the front cover only.
 These instructions apply in the UK/IE only and must be followed except for any statutory obligation.
 After installation, please leave this User Instruction manual and the Installation, Commissioning and Servicing Instructions with the user.

DEDICATED TO HEATING COMFORT

Thank you for purchasing a Greenstar Plus Hybrid manufactured by Worcester, Bosch Group. The company prides itself on manufacturing products to the strictest quality control standards throughout every stage of production.
 Worcester, Bosch Group has led the field in innovative design and performance for over 50 years. This heritage means all our products are of exceptional quality and proven reliability.

TABLE OF CONTENTS

1	Key to symbols and safety instructions	3
1.1	Explanation of symbols	3
1.2	Safety instructions	3
2	About the appliance	3
2.1	Designated use	3
2.2	EU Declaration of Conformity	3
2.3	Data plate	4
2.4	General information on heat production	4
2.5	Overview of components	5
2.5.1	Greenstar plus hybrid manager (internal unit)	5
2.5.2	Greenstar plus External unit	5
3	Preparing the hybrid system for use	6
3.1	Checking the operating pressure of the heating system	6
3.2	Top up the heating system	6
3.3	Overview of the FW200 programming unit	6
4	Starting and stopping the hybrid system	7
4.1	Stopping the hybrid system	7
4.2	Ensuring frost protection	7
4.3	Restarting the hybrid system after an interruption in operation	7
4.4	Setting up heating mode	7
4.5	Setting hybrid systems	7
4.5.1	Overview of the control modes	7
4.5.2	Installer settings: HYBRID MENU	8
4.5.3	MAIN MENU: Energy:price ratio	8
5	Environmental protection/disposal	9
5.1	Disposing of refrigerant	9
5.2	Appliance disposal	9
6	Inspection and maintenance	9
6.1	What makes regular maintenance important?	9
6.2	Cleaning and care	9
7	Energy saving tips	9
8	Faults	10
8.1	Immediately switch off the hybrid system	10
8.2	Fault display on the controller FW 200	10
9	Your Guarantee	10
10	Appendix	11
10.1	Cost weighting of electricity price - gas price	11

1 KEY TO SYMBOLS AND SAFETY INSTRUCTIONS

1.1 EXPLANATION OF SYMBOLS

WARNINGS

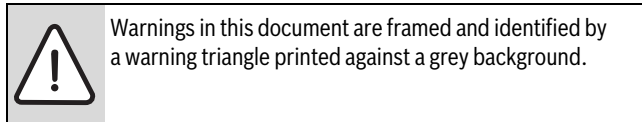

Keywords at the start of a warning indicate the type and severity of the ensuing risk if measures to prevent the risk are not taken.

- **NOTE** indicates that material losses may occur.
- **CAUTION** indicates that minor to medium injury may occur.

IMPORTANT INFORMATION

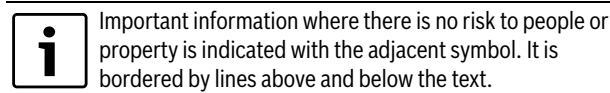

ADDITIONAL SYMBOLS

Symbol	Explanation
1.	A number step in an action sequence
▶	Action step
→	Cross-reference to other parts of this document or to other documents
①	A reference number to identify or refer to a part or item
•	List/list entry
–	List/list entry (second level)

Table 1

1.2 SAFETY INSTRUCTIONS

PRODUCT SAFETY

The hybrid system has been designed and built in accordance with currently recognised standards and safety requirements. Nevertheless, incorrect use can result in injury and material losses.

Use this product:

- only as intended
- only in perfect technical condition
- with awareness of safety concerns and hazards.

TRAINING

Your installer will make you thoroughly familiar with the function of this hybrid system, its safe and correct operation as well as correct and environmentally responsible heating.

- ▶ Complete the commissioning and handover report together with the installer.
- ▶ Let the installer hand over to you the technical documentation and all accessories for the hybrid system.

WHAT TO DO IF REFRIGERANT LEAKS

The air to water heat pump is filled with R410A refrigerant. If refrigerant leaks and touches skin, it can cause severe frost burns.

- ▶ In case of a refrigerant leak, never touch any part of the air to water heat pump.
- ▶ Avoid skin or eye contact with refrigerant.
- ▶ Seek medical attention if you get refrigerant on your skin or in your eyes.

DANGER POSED BY EXPLOSIVE AND EASILY FLAMMABLE MATERIALS

- ▶ Never use or store easily flammable materials (paper, thinners, paints etc.) near the appliances.

DAMAGE THROUGH OPERATOR ERROR

Operator errors can result in injury and/or material losses.

- ▶ Ensure that children never operate this appliance unsupervised or play with it.
- ▶ Ensure that only individuals who can operate this appliance correctly have access to it.

SITING AND CONVERSION

- ▶ Only have the appliance installed by a competent person. Modification for any other use is forbidden.
- ▶ Never close the outlets of any safety valves.

COMMISSIONING

- ▶ The hybrid system and the components may only be commissioned by a competent person.

MAINTENANCE AND TROUBLESHOOTING

- ▶ The appliances must be maintained on an annual basis by a competent person. Failure to do so may invalidate your warranty.
- ▶ Use only original Worcester spare parts and accessories. Losses caused by the use of parts not supplied by Worcester are excluded from the Worcester warranty.

2 ABOUT THE APPLIANCE

2.1 DESIGNATED USE

The appliance may only be installed in a sealed unvented hot water central heating systems to EN 12828. Any other use is considered improper. Any damage that may result is excluded from liability. The commercial and industrial use of the appliance for generating process heat is not permitted.

- Information regarding permissible operating conditions can be found in the relevant chapters of the installation and maintenance instructions for contractors.
- The following floor standing gas condensing boilers up to 28 kW can be used in the hybrid system:
 - Greenstar 29, 34, 38 & 42 CDi Classic Combi
 - Greenstar 25 & 30Si
 - Greenstar Highflow 440CDi & 550CDi
 - Greenstar 28, 32 & 36CDi Compact
 - Greenstar 30CDi System Classic
 - Greenstar 12, 15, 18 & 24i System
- Operate the appliance exclusively with R410A refrigerant.

Correct use includes adherence to maintenance and inspection intervals.

2.2 EU DECLARATION OF CONFORMITY

The design and operation of this product conforms to the European Directives and the supplementary national requirements. Its conformity is demonstrated by the CE designation.

2.3 DATA PLATE

On the data plate you will find details of the part number, appliance output and approval data.

On the hybrid manager, a data plate is affixed to the right hand side panel of the casing.

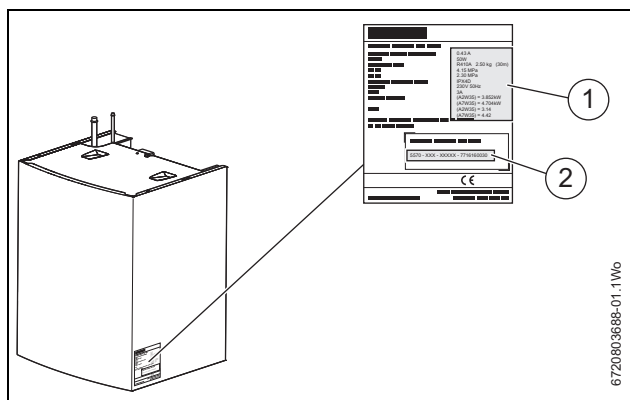

Fig. 1 Data plate on the hybrid manager (internal unit)

- [1] Unit data
- [2] Serial number

On the external unit, the data plate is located under the service cover.



The service cover may only be removed by a competent person.

2.4 GENERAL INFORMATION ON HEAT PRODUCTION

Buildings can be heated efficiently with condensing boilers and air to water heat pumps. However, these two technologies have different performance characteristics.

Condensing boilers as well as air to water heat pumps use energy gained from fossil fuels. In condensing boilers, gas is burnt directly inside the appliance.

Air to water heat pumps use electrical energy which has been obtained from a number of different sources. This includes fossil-fuel-burning power stations. These are typically around 40 % efficient in converting fuel to useful electricity. Although an air to water heat pump is far more efficient than a condensing boiler at converting its input energy (electricity) into heat, the electricity used has a larger amount of fossil-fuel consumption attached. This consumption of fossil fuels is referred to as the primary energy factor (PEF).

The fan draws ambient air via the evaporator of the air to water heat pump. This extracts heat from the ambient air. The compressor mechanically increases the temperature and transfers it to the water circuit.

The PEF of electricity is generally 2.3, the PEF of oil and gas is 1.1, the PEF of mixed electric power 2.6. The coefficient of performance (COP) of an air to water heat pump is, subject to outside temperature and water flow temperature, between 2 and 5.5.

Depending on the current situation and heat demand, either the condensing boiler or the air to water heat pump may offer a more favourable energy-to-cost ratio.

The hybrid package integrates both technologies in one system and thereby offers the opportunity to use either heat source optimally at any time. Users can decide for themselves whether the emphasis should be on primary energy consumption and/or whether costs take priority, alternatively, a combination of primary energy and costs can be used.

GENERAL FUNCTIONS

The hybrid control module determines the proportion of the total energy expenditure that will be covered by either the condensing boiler or the external unit, thereby optimizing the efficiency of the heating system.

After flowing through the hybrid manager, the heating water returns either directly to the heating system or first through the condensing boiler and then onwards to the heating system.

A high efficiency (HE) pump integrated into the hybrid manager provides the heating water circulation inside the hybrid manager. Only the HE pump inside the hybrid manager runs as long as the air to water heat pump operates on its own.

The pump inside the condensing boiler and the HE pump inside the hybrid manager run concurrently if either the condensing boiler on its own or condensing boiler and air to water heat pump operate simultaneously.

A filter with sieve inside the hybrid manager protects the heat exchanger and the heating system from contamination through small particles.

A flow switch with magnetic toggle switch ensures that the external unit only operates as long as the water flow rate is adequate for the Hybrid Manager.

The heat transfer between the refrigerant (R410A) and the heating water takes place inside the heat exchanger of the Hybrid Manager.

AUTOMATIC DEFROST FUNCTION

Ice forms on the external unit at low temperatures ($\leq 7^\circ\text{C}$). In the temperature range of $+7^\circ\text{C}$ to -9°C , heat from the heating system water is used briefly to automatically defrost the external unit.

During defrosting, the boiler remains available for heating the heating water. The defrost cycle takes approx. 5 minutes.

2.5 OVERVIEW OF COMPONENTS

2.5.1 GREENSTAR PLUS HYBRID MANAGER (INTERNAL UNIT)

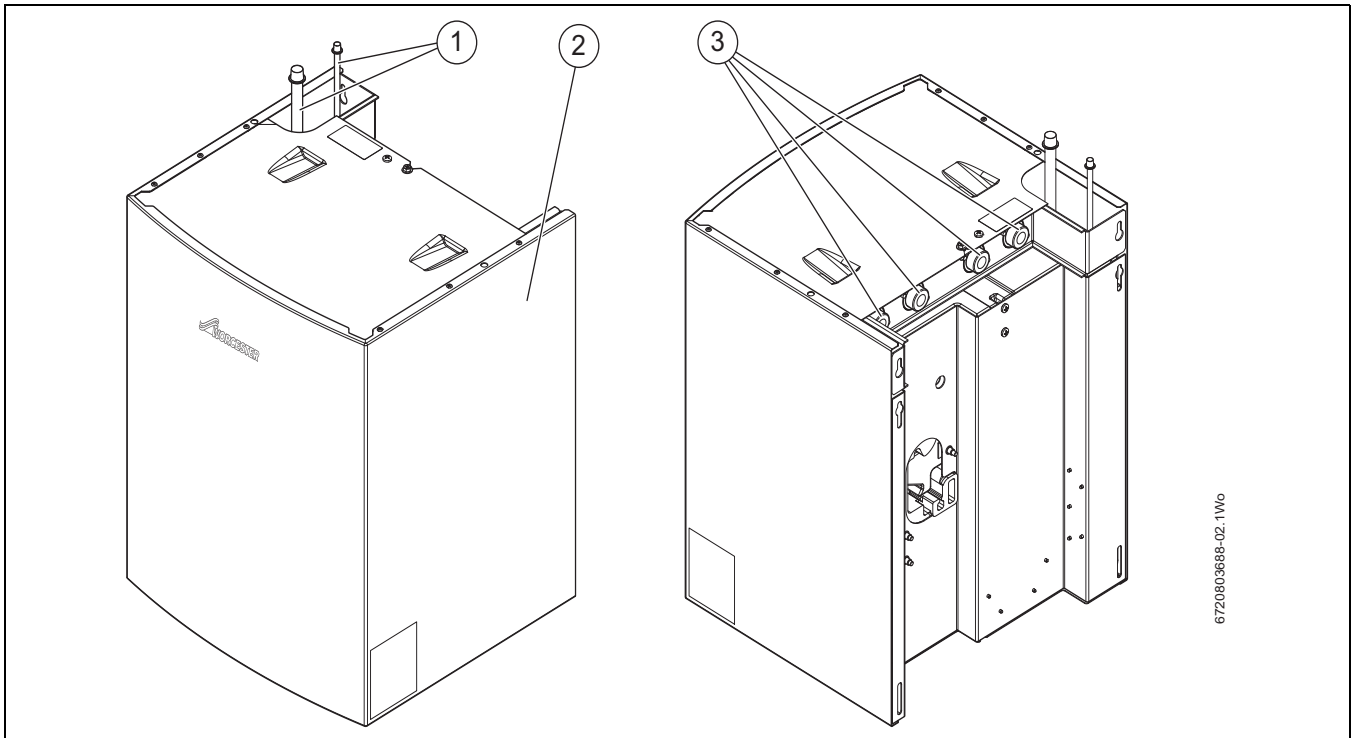

Fig. 2 Main components of the hybrid manager

- [1] Refrigerant lines for the refrigerant (R410A)
- [2] Casing
- [3] Water pipe connections

2.5.2 GREENSTAR PLUS EXTERNAL UNIT

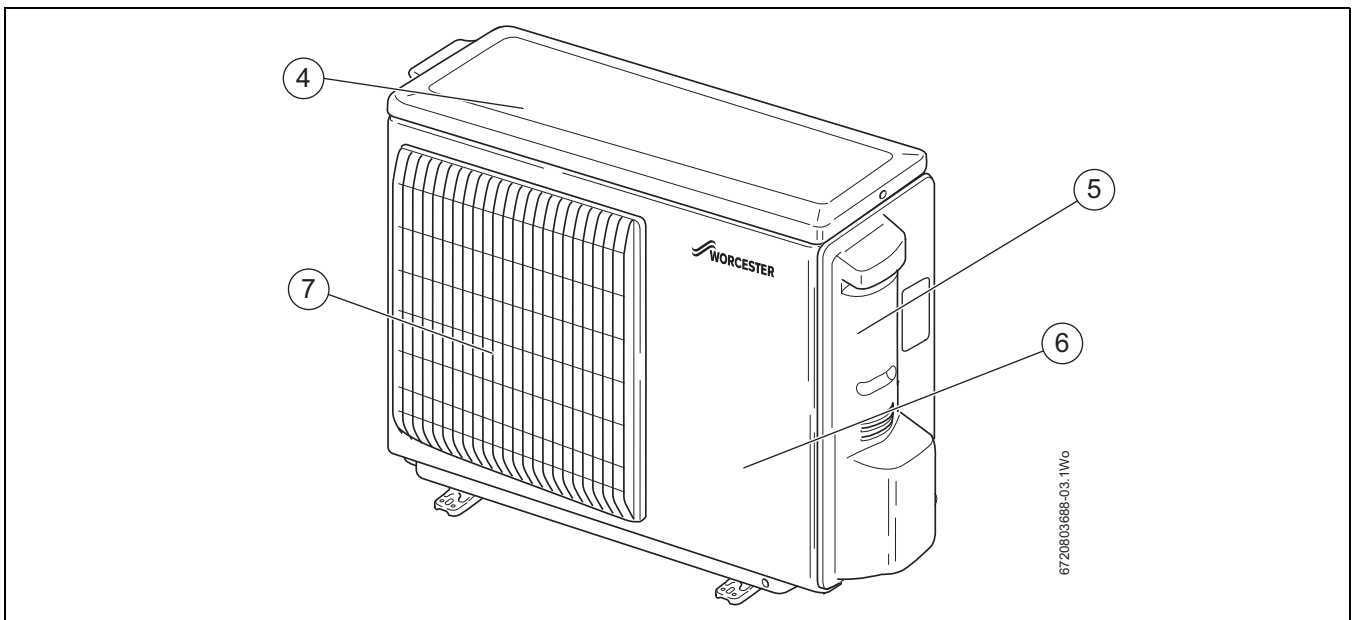

Fig. 3 Main components and casing of external unit

- [4] Top casing panel
- [5] Service panel
- [6] Front of casing panel
- [7] Air grille
- [-] Finned heat exchanger (evaporator) at the rear of the external unit

3 PREPARING THE HYBRID SYSTEM FOR USE

i Observe the information on the required steps in the operating instructions of the separate components.

3.1 CHECKING THE OPERATING PRESSURE OF THE HEATING SYSTEM

i Generally, the operating pressure is 1 to 2 bar. Should a higher operating pressure be required, refer to your heating contractor.

3.3 OVERVIEW OF THE FW200 PROGRAMMING UNIT

i The hybrid system is regulated by means of the weather-compensated FW200 programming unit.

The hybrid control module regulates the times the air to water heat pump and the condensing boiler are in use, subject to the parameters entered into the FW200.

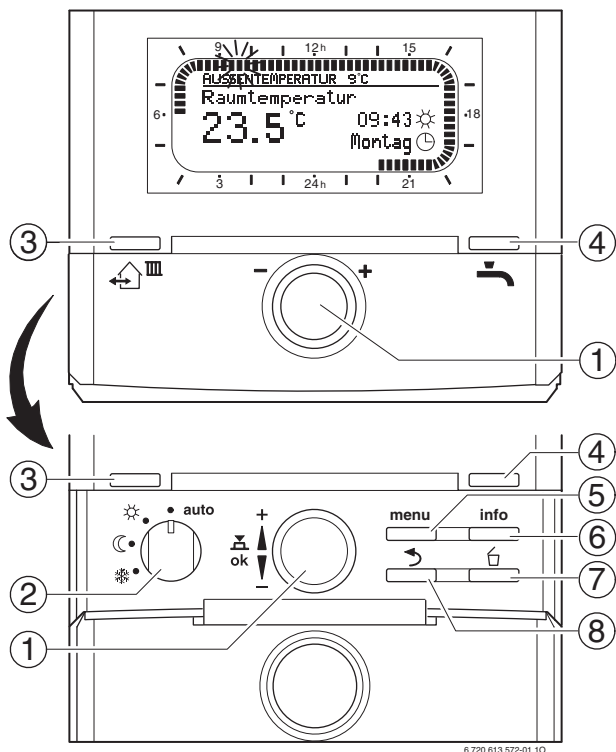

Fig. 4 FW200 programming unit

► Regularly check the operating pressure to ensure that the heating system remains operational.

i The separate operating instructions of the corresponding condensing boiler includes information on the steps required.

3.2 TOP UP THE HEATING SYSTEM

Topping up heating water is different for individual heating systems. Therefore, ask your installer to advise you accordingly.













The **maximum pressure** of 3 bar at the highest heating water temperature must not be exceeded (safety valve in the condensing boiler opens).

Keyboards

1	Turning the selector in + direction: Selects menu/information above or increases setting value
	Turning the selector in - direction: Selects menu/information below or decreases setting value
	Pushing the selector : Opens menu or confirms setting/value Switches heating circuit
2	Mode selector for heating circuits:
	auto Automatic mode
	Continuous Comfort
	Continuous Economy
	Continuous Frost
3	button: In order to bring forwards the next switching time and associated operating mode ☀ = Comfort ☾ = Economy ❄ = Frost for the heating circuit to the current time.
	button: In order to activate DHW heating immediately. The DHW cylinder is heated to the desired temperature for 60 minutes or, with combination boilers, comfort mode is activated for 30 minutes. If the ECO button is active for combi boilers, the button has no function.
5	button: Open/close menu Open INSTALLER SETTINGS: Hold down for approx. 3 seconds
6	button: Display values
7	Key : Delete/reset value
8	Key : Return to next menu level up

i To make the further description easier

- controls and operating modes are sometimes only depicted with symbols, e.g. or .
- menu levels are separated by the > symbol, e.g. **Holiday>Start**.

Symbols	
23.5 °C	Current room temperature
	Flashing segment: Current time (09:30 to 09:45)
	Solid segments: Time set for operating mode ☀ = Comfort today (1 segment = 15 min)
	Empty segments: Time set for operating mode ☾ = Economy today (1 segment = 15 min)
	No segments: Time set for operating mode ❄ = Frost today (1 segment = 15 min)
☀	Operating mode Comfort for heating circuit
☾	Operating mode Economy for heating circuit
❄	Operating mode Frost for heating circuit
	Automatic mode for heating circuit
	Holiday mode
	Burner operation on display for heating circuit
+	Scroll menu/info text up or increase value
-	Scroll menu/info text down or decrease value
OK	Open menu, confirm setting/value or switch heating circuit
	Return to next menu up
	Delete/reset value
	Bring forwards the next switching time and the associated operating mode ☀ = Comfort ☾ = Economy ❄ = Frost for the heating circuit to now.
	Activate DHW heating immediately. The DHW cylinder is heated to the required temperature for 60 minutes or, with combi boilers, comfort mode is activated for 30 minutes. If the ECO button is active for combi boilers, the  button has no function.

4 STARTING AND STOPPING THE HYBRID SYSTEM

The specified sequences and delays must always be observed when starting and stopping the hybrid system. Otherwise the hybrid system components could suffer severe damage.

4.1 STOPPING THE HYBRID SYSTEM



The hybrid control module regulates the times the air to water heat pump and the condensing boiler are in use, subject to the parameters entered into the FW200 programming unit.

- ▶ Never isolate the power supply to the hybrid manager and the external unit during standard operation.

Switching off the hybrid system:

- ▶ Reset any current heat demands using the programming unit.
- ▶ After stopping the operation, wait at least 5 minutes. Only then isolate the power supply to the hybrid manager and the external unit. Otherwise, water leakage or breakdown may result.

4.2 ENSURING FROST PROTECTION



NOTICE: Frost damage

When the heating system is switched off, it can freeze up if there is a frost.

- ▶ In the case of a risk of frost, have the DHW circuit drained by an a competent person or mix antifreeze that is approved for use with the respective condensing boiler into the heating water.



Whether antifreeze may be used and which type is permissible depends on the installed condensing boiler.

- ▶ Observe the details in the condensing boiler installation instructions.

4.3 RESTARTING THE HYBRID SYSTEM AFTER AN INTERRUPTION IN OPERATION



NOTICE: Damage to the external unit from low operating temperature.

When restoring the power supply following an interruption of operation.

The Power supply to the external unit must be 'live' for at least 12 hours before starting operation. This is to ensure that the compressor is warmed up sufficiently to avoid any liquid refrigerant from entering the compressor. This is particularly important during colder periods.

The 12 hour period also compensates for any unsettling of the lubricating oil within the compressor which may have occurred during transportation. If this 12 hour time period cannot be met damage to the outdoor unit may result.

- ▶ If the appliances fail to start contact your installer.

4.4 SETTING UP HEATING MODE

Make the following adjustments on the condensing boiler or on the FW200 programming unit:

- Maximum flow temperature

With underfloor heating systems observe the maximum permissible flow temperature. Older underfloor heating systems generally require higher flow temperatures than more modern systems.

- Maximum DHW temperature
- Setback mode
- Summer mode
- Frost protection



The separate operating instructions of the condensing boiler or the FW200 programming unit include information on the steps required.

4.5 SETTING HYBRID SYSTEMS

4.5.1 OVERVIEW OF THE CONTROL MODES



These parameters can be set either via the FW 200 weather-compensated controller or via the hybrid control module. These values are transferred and overwritten respectively. The following section will describe how to make the settings using the FW 200 weather-compensated controller.

STARTING AND STOPPING THE HYBRID SYSTEM

You can check which of the following control modes the contractor has set for you in the Info menu (→ technical documentation FW200) on the FW200 weather-compensated controller.

- **CO₂-optimised**
With CO₂-optimised mode, the system control decides when operating the heat pump or boiler results in the greatest CO₂ reduction.
- **Cost-optimised**
With the cost-optimised mode, the system control decides on the basis of current energy prices. Rising gas prices result in longer operation of the heat pump, whilst rising electricity prices result in longer operation of the boiler.
- **Changeover temperature**
With outside temperature-dependent mode, the boiler starts operating from a defined outside temperature.
- **CO₂:cost mix**
Mixed mode comprising environmental factors and costs. Environmental aspects and financial aspects are both taken into account.

4.5.2 INSTALLER SETTINGS: HYBRID MENU

The following parameters must be set by the installer:

Control modes for hybrid systems:

- **CO₂-optimised**
- **Cost-optimised**
- **Changeover temperature**
- **CO₂:cost mix**

4.5.3 MAIN MENU: ENERGY:PRICE RATIO

This menu option is only available if the **control strategy** has been set to **cost-optimised** or **CO₂-cost-Mix** at contractor level.

Operation		Display
▶ Open flap.		
▶ The standard display continues to be shown.		
Calling up the main menu:		
Press 	The MAIN MENU is displayed.	
Turn 	▶ Highlight the Hybrid menu option.	
Press 	▶ Confirm the selected Hybrid menu option. The Hybrid menu is displayed.	
Turn 	▶ Highlight the Energy:price ratio menu option.	
Press 	▶ Confirm the selected Energy:price ratio menu option.	
Turn 	▶ Set the required value. Setting range: 0.0 to 19.9 Factory setting: 3.3 (see table 3, page 11)	
Press 	▶ Call up the next menu up.	
-or-		
Turn 	▶ Highlight the < Back menu option.	
Press 	▶ Confirm the < Back menu option. The next menu up is displayed.	

Table 2 Setting the energy price ratio Electricity/fossil fuel

5 ENVIRONMENTAL PROTECTION/DISPOSAL

Environmental protection is one of the fundamental company policies of the Bosch Group.

Quality of products, efficiency and environmental protection are equally important objectives for us. Laws and requirements aimed at protecting the environment are strictly adhered to.

To protect the environment we will, subject to economical aspects, use the best possible technology and materials.

PACKAGING

We participate in the recycling programmes of the countries in which our products are sold to ensure optimum recycling.

All of our packaging materials are environmentally compatible and can be recycled.

5.1 DISPOSING OF REFRIGERANT

The appliance is charged with R410A refrigerant.

R410A is a greenhouse gas. It must not enter the environment.



CAUTION: Incorrect disposal is an environmental hazard!
Escaping refrigerant damages the environment.

- ▶ Refrigerant may be disposed of by qualified contractors only.

- ▶ If you wish to discard refrigerant, please contact your local authorities and ask for the correct method of disposal.

5.2 APPLIANCE DISPOSAL

Old appliances contain materials that should be recycled.

The appliance is marked with the  symbol.



Appliances with this symbol may not be disposed of in the normal refuse (e.g. dust bin) at the end of their service life.

- ▶ Sort and dispose of packaging materials according to the national recycling system.
- ▶ Have an authorised contractor dispose of the appliance and any accessories according to the local regulations.
- ▶ Do not dispose of the appliance in the normal refuse (e.g. dust bin).
- ▶ If the appliances have batteries or rechargeable batteries, dispose of these separately beforehand according to local regulations.
- ▶ Dispose of electric and electronic equipment separately according to local requirements.

6 INSPECTION AND MAINTENANCE



NOTICE: Material losses due to a lack of or incorrect cleaning and maintenance.

- ▶ Have your hybrid system inspected, serviced and cleaned annually by an authorised contractor.
- ▶ We recommend you enter a contract covering an annual inspection and service subject to demand.

6.1 WHAT MAKES REGULAR MAINTENANCE IMPORTANT?

Regular service is essential for the following reasons:

- to maintain a high level of efficiency and to operate the hybrid system economically
- to achieve a high level of operational reliability.

6.2 CLEANING AND CARE

Clean the casing of the hybrid manager and the external unit with a damp cloth (detergent solution). Never use scouring or aggressive cleaning agents that would damage the painted surface or plastic components.

7 ENERGY SAVING TIPS

INSPECTION/MAINTENANCE

So that gas consumption and environmental impact can be kept as low as possible for as long as possible, we recommend that you take out an inspection and maintenance contract with an authorised contractor covering an annual inspection and service subject to demand.

HEATING CONTROLS

With modern heating systems designed around a 20 °C heat loss across the system. The system must be balanced correctly and the radiators may need upgrading.

The temperature of each room can be set individually (except primary room with the room thermostat) using the thermostatic radiator valves.

Reducing the setting of the room thermostat by 1°C can reduce fuel consumption by up to 10%.

For further information, see the relevant installation and operating instructions of the controller.

THERMOSTATIC VALVES

Fully open the thermostatic radiator valves in order to achieve the required room temperature. Change the required room temperature at the programming unit only if the temperature is not achieved after a prolonged period.

RADIATORS

If a radiator is sited underneath a window, its performance will be affected if the curtains are allowed to drape over the radiator.

Shelves fitted above or in front of the radiator should also be avoided.

It is advisable to manually adjust all thermostatic radiator valves every 2 - 3 months to prevent them sticking. Ensure radiator valves are correctly set and not damaged.

UNDERFLOOR HEATING SYSTEM

Never set the flow temperature higher than the maximum flow temperature recommended by the manufacturer.

ROOF INSULATION

Around 30% of the heat loss from a property is through the roof. Replace any old insulation with new insulation, preferably of around 200mm thickness or more.

WINDOW FRAMES

Single glazed windows, particularly those with steel frames, can lose a great deal of heat. Consideration should be given to replacement with PVCu or wooden framed double glazed units.

DRAUGHTS

Try to ensure that draughts around doors, windows, letter boxes and keyholes etc. are reduced by using a suitable draught excluder.

	<p>WARNING: Air vents</p> <p>▶ Do not block or seal any air vents that are installed to ensure that the central heating boiler operates safely.</p>
---	--

CURTAINS

Lined curtains, or heavier full length curtains can provide excellent insulation. However, always ensure that the curtains do not drape over radiators.

8 FAULTS

8.1 IMMEDIATELY SWITCH OFF THE HYBRID SYSTEM

Should one of the following situations occur, disconnect the power supply to the hybrid manager and the external unit and contact your installer.

The hybrid system must not continue to be operated under the following circumstances:

- One fuse/MCB of the hybrid system responds/blows with excessive frequency.
- Splashed water or flash water has penetrated the hybrid manager.
- Water drips from the hybrid manager.
- The hybrid system makes unusual noises during operation.

8.2 FAULT DISPLAY ON THE CONTROLLER FW 200

A malfunction in your heating system will be indicated on the controller display.

The cause may be a malfunction of the boiler, controller or hybrid manager / heat pump.

If the boiler is the cause of the failure please refer to the relevant boiler manual.

If the controller is the cause of the failure please refer to the FW200 manual.

If the hybrid manager / heat pump is the cause of the failure please contact your authorized dealer or customer service centre.

9 YOUR GUARANTEE

This appliance has a guarantee against faulty materials or workmanship for a period of two years from the date of installation subject to the following terms and conditions:

- During the period of this guarantee any components of the appliance which are proven to be faulty or defective in manufacture will be exchanged or repaired free of charge by Bosch Thermotechnology Ltd.
- The householder may be asked to prove the date of installation, that the boiler was correctly commissioned and, where appropriate, the first year's service has been carried out to the satisfaction of Bosch Thermotechnology Ltd., when requested. These should be documented as a part of the Benchmark Checklist.
- The appliance has been used only for the normal domestic purposes for which it was designed.

This guarantee does not affect your statutory rights.

GUARANTEE REGISTRATION

Your Greenstar appliance carries a two year guarantee against faulty material or manufacturer subject to Terms and Conditions. To read the full Terms & Conditions please visit us on-line at www.worcester-bosch.co.uk/guarantee. The Guarantee Registration form is available on this same page and can be completed and submitted electronically.

Alternatively, please telephone one of our Guarantee Registration advisors on 0844 892 2552.

Your statutory rights are not affected by the manufacturers guarantee.

FOR YOUR OWN RECORD

Please ensure that the Benchmark Checklist has been completed by your installer or service engineer.

When requesting a customer service visit, it is useful to provide detailed information about your appliance.

You will find these details on the data plate.

Product:

Serial number:

Date of manufacture:

Commissioning date:

System installer:

10 APPENDIX

10.1 COST WEIGHTING OF ELECTRICITY PRICE - GAS PRICE

		Electricity price [P/kWh]																				
		10.0-10.9	11.0-11.9	12.0-12.9	13.0-13.9	14.0-14.9	15.0-15.9	16.0-16.9	17.0-17.9	18.0-18.9	19.0-19.9	20.0-20.9	21.0-21.9	22.0-22.9	23.0-23.9	24.0-24.9	25.0-25.9	26.0-26.9	27.0-27.9	28.0-28.9	29.0-29.9	30.0-30.9
Gas price [P/kWh]	3.0-3.9	2.8	3.0	3.3	3.5	3.8	4.1	4.3	4.6	4.9	5.1	5.4	5.7	5.9	6.2	6.4	6.7	7.7	7.2	7.5	7.8	8.8
	4.0-4.9	2.1	2.3	2.5	2.7	3.0	3.2	3.4	3.6	3.8	4.0	4.2	4.4	4.6	4.8	5.0	5.2	5.4	5.6	5.8	6.0	6.2
	5.0-5.9	1.7	1.9	2.1	2.2	2.4	2.6	2.7	2.9	3.1	3.2	3.4	3.6	3.7	3.9	4.1	4.2	4.4	4.6	4.7	4.9	5.1
	6.0-6.9	1.5	1.6	1.8	1.9	2.0	2.2	2.3	2.5	2.6	2.7	2.9	3.0	3.2	3.3	3.4	3.6	3.7	3.9	4.0	4.2	4.3
	7.0-7.9	1.3	1.4	1.5	1.6	1.8	1.9	2.0	2.1	2.3	2.4	2.5	2.6	2.7	2.9	3.0	3.1	3.2	3.3	3.5	3.6	3.7
	8.0-8.9	1.1	1.2	1.3	1.4	1.6	1.7	1.8	1.9	2.0	2.1	2.2	2.3	2.4	2.5	2.6	2.7	2.8	3.0	3.1	3.2	3.3
	9.0-9.9	1.0	1.1	1.2	1.3	1.4	1.5	1.6	1.7	1.8	1.9	2.0	2.1	2.2	2.3	2.4	2.4	2.5	2.6	2.7	2.8	2.9
	10.0-10.9	0.9	0.9	1.1	1.2	1.3	1.3	1.4	1.5	1.6	1.7	1.8	1.9	2.0	2.0	2.1	2.2	2.3	2.4	2.5	2.6	2.6
	11.0-11.9	0.8	0.9	1.0	1.1	1.1	1.2	1.3	1.4	1.5	1.5	1.6	1.7	1.8	1.9	1.9	2.0	2.1	2.2	2.3	2.3	2.4
	12.0-12.9	0.8	0.8	0.9	1.0	1.1	1.1	1.2	1.3	1.3	1.4	1.3	1.6	1.6	1.7	1.8	1.9	1.9	2.0	2.1	2.2	2.2
	13.0-13.9	0.7	0.8	0.8	0.9	1.0	1.0	1.1	1.2	1.2	1.3	1.2	1.4	1.5	1.6	1.7	1.7	1.8	1.9	1.9	2.0	2.1
	14.0-14.9	0.7	0.7	0.8	0.8	0.9	1.0	1.0	1.1	1.2	1.2	1.2	1.3	1.4	1.5	1.5	1.6	1.7	1.7	1.8	1.9	1.9
	15.0-15.9	0.6	0.7	0.7	0.8	0.9	0.9	1,	1.0	1.1	1.1	1.1	1.1	1.3	1.3	1.4	1.4	1.5	1.6	1.6	1.7	1.8
	16.0-16.9	0.6	0.6	0.7	0.7	0.8	0.9	0.9	1.0	1.0	1.1	1.1	1.0	1.2	1.2	1.3	1.4	1.4	1.5	1.5	1.6	1.7

Table 3 Call-up example: cost weighting of electricity and gas prices

GLOSSARY

OPERATING PRESSURE

The operating pressure is the pressure in the heating system.

PROGRAMMING UNIT

The programming unit ensures the automatic control of the flow temperature subject to outside temperature (in case of weather-compensated controllers) in conjunction with a time programme.

INSTANTANEOUS WATER HEATER PRINCIPLE

The water is heated as it flows through the appliance. The maximum draw-off rate is quickly available, i.e. without long waiting times or interruptions for the heat-up process.

HEATING RETURN

The heating return is the pipework that returns the heating water at a lower temperature from the radiators/underfloor heating system etc. to the heat source.

HEATING WATER

Heating water is the water that circulates in the heating system.

COEFFICIENT OF PERFORMANCE

The coefficient of performance ϵ , (COP), is the actual or calculated identifier for air to water heat pumps under specified operating conditions, similar to the standardised fuel consumption for vehicles.

The coefficient of performance ϵ describes the ratio between the available heating energy and the power drawn by the compressor.

PRIMARY ENERGY FACTOR (PEF)

The consumption of fossil fuels is referred to as the primary energy factor (PEF).

THERMOSTATIC VALVE

Thermostatic valves are mechanical temperature controllers that enables a lower or higher heating water flow rate subject to ambient temperature in order to maintain a constant temperature.

FLOW TEMPERATURE

Flow temperature is the temperature with which the heated heating water flows from the appliance to the radiators, underfloor heating circuits, etc.

EFFICIENCY

Efficiency describes the ratio between available output and energy input. Under ideal circumstances, the efficiency is 1. Technical processes always involve some losses, hence the efficiency of technical equipment is always below 1.

Air to water heat pumps draw a large proportion of the energy [they deliver] from the environment. This portion of energy is not described as supplied energy, as it is free of charge. Were the efficiency under these conditions to be calculated, it would be ≥ 1 . As this would not be correct, the coefficient of performance (COP) was introduced for air to water heat pumps in order to describe the ratio between available or useful energy to that which has been expended (in this case purely the working energy). The coefficient of performance for air to water heat pumps lies between 3 and 6.

Worcester, Bosch Group
Cotswold Way, Warndon, Worcester WR4 9SW.
Tel. 0844 892 9900

Worcester, Bosch Group is a brand name of Bosch Thermotechnology Ltd.
worcester-bosch.co.uk

6 720 803 688 (2012/11)

WORCESTER, BOSCH GROUP:

TECHNICAL SUPPORT: 0844 892 3366
APPOINTMENTS: 0844 892 3000
SPARES: 01905 752571
LITERATURE: 0844 892 9800
TRAINING: 01905 752526
SALES: 01905 752640

The logo for Worcester Bosch Group features a stylized, wavy graphic element on the left, composed of three overlapping, curved lines in shades of grey. To the right of this graphic, the word "WORCESTER" is written in a large, bold, black, sans-serif font. Below "WORCESTER", the words "Bosch Group" are written in a smaller, bold, black, sans-serif font.

WORCESTER
Bosch Group